

# Installation and operating instructions

## *SPRAYER-Controller MAXI and MIDI 3.0*



---

Version: V6.20200615



30303187-02-EN

Read and follow these instructions. Keep these instructions in a safe place for later reference. Please note that there might be a more recent version of these instructions on the homepage.

## Company details

Document  
Installation and operating instructions  
Product: SPRAYER-Controller MAXI and MIDI 3.0  
Document number: 30303187-02-EN  
As of software version: 07.09.XX  
Original instructions  
Original language: German

Copyright ©  
Müller-Elektronik GmbH  
Franz-Kleine-Straße 18  
33154 Salzkotten  
Germany  
Phone: ++49 (0) 5258 / 9834 - 0  
Fax: ++49 (0) 5258 / 9834 - 90  
Email: [info@mueller-elektronik.de](mailto:info@mueller-elektronik.de)  
Homepage: <http://www.mueller-elektronik.de>

## Table of contents

|       |                                                          |    |
|-------|----------------------------------------------------------|----|
| 1     | For your safety                                          | 7  |
| 1.1   | Basic safety instructions                                | 7  |
| 1.2   | Intended use                                             | 7  |
| 1.3   | Layout and meaning of warnings                           | 8  |
| 1.4   | Layout and meaning of alert messages                     | 8  |
| 1.5   | User requirements                                        | 9  |
| 1.6   | Safety sign for the field sprayer                        | 9  |
| 1.7   | Safety stickers on the product                           | 10 |
| 1.8   | Disposal                                                 | 10 |
| 1.9   | EU declaration of conformity                             | 10 |
| 2     | About these Operating Instructions                       | 12 |
| 2.1   | Who should read these instructions                       | 12 |
| 2.2   | Diagrams in this manual                                  | 12 |
| 2.3   | Directional information in these instructions            | 12 |
| 2.4   | Layout of operating instructions                         | 12 |
| 2.5   | Layout of references                                     | 13 |
| 3     | About the job computer                                   | 14 |
| 3.1   | Job computer functions                                   | 14 |
| 3.2   | System Overview                                          | 14 |
| 3.2.1 | Main system - MAXI                                       | 15 |
| 3.2.2 | Main system - MIDI                                       | 16 |
| 3.2.3 | Extension: DISTANCE-Control II                           | 16 |
| 3.2.4 | Extension: TANK-Control III                              | 17 |
| 3.2.5 | Extension: EDS                                           | 17 |
| 3.3   | Software extensions                                      | 18 |
| 3.4   | Rating plate                                             | 18 |
| 4     | Mounting and installation                                | 19 |
| 4.1   | Installing the job computer                              | 19 |
| 4.1.1 | Instructions for safe installation                       | 19 |
| 4.1.2 | Connecting the AMP connectors                            | 19 |
| 4.1.3 | Separating the AMP connectors                            | 20 |
| 4.2   | Connecting the job computer to the ISOBUS                | 20 |
| 4.3   | Installing the junction box                              | 21 |
| 4.3.1 | Connecting the sensors and actuators to the junction box | 21 |
| 4.3.2 | Inserting the cable core into a terminal                 | 22 |
| 4.3.3 | Connecting the junction box to the job computer          | 22 |
| 5     | Basic control principles                                 | 23 |
| 5.1   | Switching on the job computer                            | 23 |
| 5.2   | Layout of work screen                                    | 23 |

|        |                                                         |    |
|--------|---------------------------------------------------------|----|
| 5.2.1  | Spray data area                                         | 24 |
| 5.2.2  | Boom display area                                       | 26 |
| 5.2.3  | Icons beside the implement image                        | 27 |
| 5.2.4  | Icons on the implement image                            | 31 |
| 5.3    | Control units                                           | 32 |
| 6      | Operating job computer on the field                     | 33 |
| 6.1    | Tank filling                                            | 33 |
| 6.1.1  | Filling up the tank manually without additional systems | 33 |
| 6.1.2  | Filling up the tank with TANK-Control                   | 33 |
| 6.1.3  | Filling up the tank with TANK-Control and fill stop     | 34 |
| 6.2    | Controlling the boom                                    | 35 |
| 6.2.1  | Lifting and lowering the boom                           | 36 |
| 6.2.2  | Folding and unfolding the boom                          | 36 |
| 6.2.3  | Locking the boom                                        | 38 |
| 6.2.4  | Raising and lowering the wings (tilting up / down)      | 39 |
| 6.2.5  | Sloping the boom                                        | 40 |
| 6.2.6  | Reproducing the boom slope when turning                 | 40 |
| 6.2.7  | Using additional boom sensors                           | 42 |
| 6.3    | Starting application                                    | 42 |
| 6.4    | Regulating the application rate                         | 43 |
| 6.4.1  | Changing the application rate in manual mode            | 44 |
| 6.4.2  | Using Automatic mode                                    | 44 |
| 6.4.3  | Setting target rate                                     | 46 |
| 6.4.4  | Stopping application                                    | 47 |
| 6.5    | Operating sections                                      | 47 |
| 6.6    | Documenting work results                                | 47 |
| 6.7    | Using pressure registration                             | 48 |
| 6.8    | Operating the ME joystick                               | 49 |
| 6.8.1  | Preview mode for the ME Joystick                        | 49 |
| 6.8.2  | Viewing the assignment of the joystick                  | 50 |
| 6.9    | Using foam markers                                      | 50 |
| 6.10   | Operating additional functions                          | 51 |
| 6.11   | Regulating the drop size with AIRTEC                    | 52 |
| 6.11.1 | Switching the air compressor on and off                 | 54 |
| 6.11.2 | AIRTEC in automatic mode                                | 54 |
| 6.11.3 | AIRTEC in manual mode                                   | 55 |
| 6.12   | Using the ISB short-cut button                          | 55 |
| 7      | Configuring the job computer                            | 56 |
| 7.1    | Entering sprayer parameters                             | 56 |
| 7.1.1  | <b>“Nozzle” parameter</b>                               | 56 |
| 7.1.2  | <b>“Target Rate” parameter</b>                          | 56 |
| 7.1.3  | <b>“Jump start time” parameter</b>                      | 56 |
| 7.1.4  | <b>“Working Width” parameter</b>                        | 56 |
| 7.1.5  | <b>“Wheel Impulses” parameter</b>                       | 57 |
| 7.1.6  | <b>“Minimum Pressure” parameter</b>                     | 57 |

|        |                                                                        |    |
|--------|------------------------------------------------------------------------|----|
| 7.1.7  | “Maximum Pressure” parameter                                           | 57 |
| 7.1.8  | “Sprayer off Below” parameter                                          | 57 |
| 7.1.9  | “Regulation off Below” parameter                                       | 57 |
| 7.1.10 | “Regulation Factor” parameter                                          | 57 |
| 7.1.11 | “Tank Size” parameter                                                  | 58 |
| 7.1.12 | “Tank level alarm” parameter                                           | 58 |
| 7.1.13 | “Impulses Main Flow” parameter                                         | 58 |
| 7.1.14 | “Stirring off Below” parameter                                         | 58 |
| 7.1.15 | “Maximum Wind Speed” parameter                                         | 58 |
| 7.1.16 | “Extremity nozzles set” parameter                                      | 58 |
| 7.1.17 | “Pump” parameter                                                       | 58 |
| 7.1.18 | “Section Control” parameter                                            | 59 |
| 7.1.19 | “Filling Mode” parameter                                               | 59 |
| 7.1.20 | “Circulation Type” parameter                                           | 59 |
| 7.2    | Configuring the control units                                          | 59 |
| 7.3    | Calibrating the flow meter                                             | 60 |
| 7.3.1  | Calibrating the flow meter with the tank method                        | 60 |
| 7.3.2  | Calibrating the flow meter with the nozzle method                      | 62 |
| 7.3.3  | Manually entering the number of impulses per liter for the flow meter  | 64 |
| 7.3.4  | Combining the flow meter with the pressure sensor                      | 64 |
|        | “Flow Tolerance” parameter                                             | 65 |
|        | “Threshold Flow” parameter                                             | 65 |
| 7.4    | Calibrating an analogue pressure sensor                                | 65 |
| 7.5    | Selecting and configuring the speed sensor                             | 66 |
| 7.5.1  | Selecting the speed source                                             | 66 |
| 7.5.2  | Calibrating the speed sensor with the 100m method                      | 66 |
| 7.5.3  | Configuring the reverse driving sensor                                 | 67 |
| 7.5.4  | “Simulated Speed” function                                             | 68 |
| 7.6    | Configuring sections                                                   | 68 |
| 7.6.1  | Entering the number of nozzles per section                             | 68 |
| 7.6.2  | Switching sections off permanently                                     | 68 |
| 7.6.3  | Permanently switching off a section using a sensor                     | 69 |
| 7.6.4  | System delay when switching the sections                               | 69 |
|        | “Delay on Start” parameter                                             | 70 |
|        | “Delay on Stop” parameter                                              | 70 |
| 7.6.5  | Changing the display of areas on the terminal                          | 70 |
| 7.7    | Configuring the nozzles - for sprayers with pressure sensor regulation | 71 |
| 7.7.1  | Nozzle assistant                                                       | 71 |
| 7.7.2  | Calibrate the nozzles                                                  | 73 |
| 7.8    | Extremity nozzles                                                      | 74 |
| 7.8.1  | Configuring the extremity nozzles                                      | 75 |
| 7.8.2  | Operating the extremity nozzles                                        | 76 |
| 7.9    | Configuring AIRTEC                                                     | 77 |
| 7.10   | Entering the sprayer geometry                                          | 77 |
| 7.11   | Configuring the Raven direct injection                                 | 78 |
| 7.12   | Calibrating the sensors for reproducing the boom slope                 | 79 |
| 7.13   | Field sprayer with two circulations and job computers                  | 80 |

|        |                                                    |    |
|--------|----------------------------------------------------|----|
| 7.13.1 | Identifying the job computer                       | 81 |
| 7.13.2 | Geometry on a field sprayer with two job computers | 82 |
| 7.14   | Activating licenses                                | 83 |
| 7.15   | Assigning the joystick buttons                     | 83 |
| 8      | Troubleshooting                                    | 84 |
| 8.1    | Checking the software version                      | 84 |
| 9      | Technical specifications                           | 85 |
| 9.1    | ECU-MIDI 3.0 job computer                          | 85 |
| 9.2    | ECU-MAXI 3.0 job computer                          | 86 |
| 9.3    | Available languages                                | 86 |

# 1 For your safety

## 1.1 Basic safety instructions

### Operation



Be sure to always comply with the following instructions during operation:

- Before you leave the vehicle cab, ensure that all automatic mechanisms are deactivated or manual mode is activated.
- In particular, deactivate the following systems if they are installed:
  - TRAIL-Control
  - DISTANCE-Control
- Keep children away from the implement and the job computer.
- Carefully read and follow all safety instructions in this operating guide and in the machine operating instructions.
- Observe all applicable regulations on accident prevention.
- Follow all recognised safety, industrial and medical rules as well as all road traffic laws.
- Use only clear water when you are testing the sprayer. Do not use a poisonous spray during the tests or when calibrating the systems.

### Servicing



Keep the system in a functional condition. To do so, follow these instructions:

- Do not make any unauthorized modifications to the product. Unauthorized modifications or use may impair safety and reduce the service life or operability of the unit. Modifications are considered unauthorized if they are not described in the product documentation.
- Never remove any safety mechanisms or stickers from the product.
- Before charging the tractor battery, always disconnect the tractor from the job computer.
- Before performing any welding on the tractor or the implement, always disconnect the power supply to the job computer.
- The job computer and the cabling must not be repaired. Unauthorised attempts at repairs can fail and cause hazardous malfunctions.
- Use only original accessories as spare parts.

## 1.2 Intended use

The job computer is used to control machines in agriculture. The manufacturer shall not be held responsible for any installation or use that goes beyond this.

Intended use also includes compliance with the conditions for operation and repairs prescribed by the manufacturer.

The manufacturer cannot be held liable for any personal injury or property damage resulting from such non-compliance. All risk arising from improper use lies with the user.

All applicable accident prevention regulations and all other generally recognized safety, industrial, and medical standards as well as all road traffic laws must be observed. Any unauthorized modifications made to the equipment will void the manufacturer's warranty.

## 1.3 Layout and meaning of warnings

All safety instructions found in these Operating Instructions are composed in accordance with the following pattern:

|                                                                                   |                                                                                                                                         |
|-----------------------------------------------------------------------------------|-----------------------------------------------------------------------------------------------------------------------------------------|
|  |  <b>WARNING</b>                                        |
|                                                                                   | <p>This signal word identifies medium-risk hazards, which could potentially cause death or serious physical injury, if not avoided.</p> |

|                                                                                   |                                                                                                                                                  |
|-----------------------------------------------------------------------------------|--------------------------------------------------------------------------------------------------------------------------------------------------|
|  |  <b>CAUTION</b>                                                 |
|                                                                                   | <p>This signal word identifies hazards that could potentially cause minor or moderate physical injury or damage to property, if not avoided.</p> |

### NOTICE

This signal word identifies hazards that could potentially cause damage to property, if not avoided.

There are some actions that need to be performed in several steps. If there is a risk involved in carrying out any of these steps, a safety warning appears in the instructions themselves.

Safety instructions always directly precede the step involving risk and can be identified by their bold font type and a signal word.

Example

1. **NOTICE!** This is a notice. It warns that there is a risk involved in the next step.
2. Step involving risk.

## 1.4 Layout and meaning of alert messages

An alarm message may appear during operation.

Purpose

The alarm messages have the following purpose:

- **Warning** - These messages warn the operator if the current status of the field sprayer could lead to a dangerous situation.
- **Information** - These messages inform the operator that the current status of the field sprayer or configuration is not correct and could lead to faults in operation.

Illustration

On the following diagram, you can see how the alarm messages are structured:



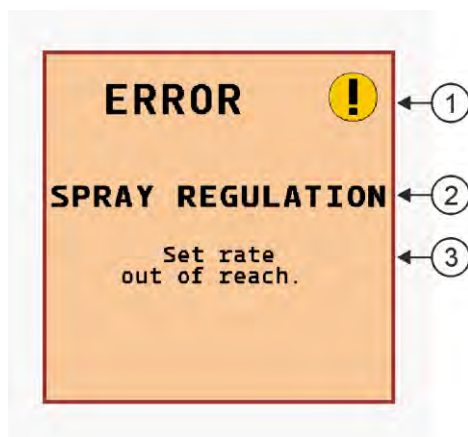

Alarm message structure

|   |                                                                                                                                                               |
|---|---------------------------------------------------------------------------------------------------------------------------------------------------------------|
| ① | Type of alarm                                                                                                                                                 |
| ② | Name of the component that caused the alarm.                                                                                                                  |
| ③ | Problem description and solution<br>Information on the exact cause of an alarm message or how to rectify a fault can be found in the section "Alarm messages" |

## 1.5

### User requirements

- Learn to operate the product in accordance with the instructions. Nobody must operate the product before reading these instructions.
- Please read and carefully observe all safety instructions and warnings contained in these Operating Instructions and in the manuals of any connected vehicles and farm equipment.
- If there is anything within these instructions that you do not understand, please do not hesitate to contact us or your dealer. Müller-Elektronik's Customer Services department will be happy to assist you.

## 1.6

### Safety sign for the field sprayer

If the field sprayer is fitted with drawbar steering or with axle steering, everyone approaching the field sprayer must be warned of possible dangers. For that reason you receive a safety sign.

1. Stick the safety sign in the appropriate place.

When attaching safety signs, observe the following:

- Safety signs must be attached at a visible location so that they can be seen by everyone approaching the danger zone.
- If the danger area can be approached from several sides of the implement, attach the warning signs on all implement sides.
- Regularly check the safety signs for completeness and legibility.
- Replace damaged or unreadable signs with new ones.

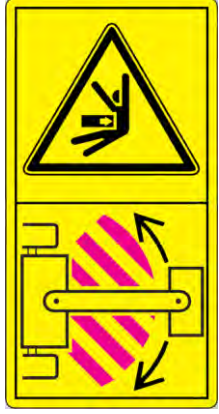
| Safety sign                                                                       | Where to attach                                               | Meaning                                        |
|-----------------------------------------------------------------------------------|---------------------------------------------------------------|------------------------------------------------|
|  | Near the the bend area between tractor and trailed implement. | Do not stay in the bend area during operation. |

## 1.7 Safety stickers on the product

Sticker on the job computer

|                                                                                    |                                            |
|------------------------------------------------------------------------------------|--------------------------------------------|
|  | Do not clean with a high-pressure cleaner. |
|------------------------------------------------------------------------------------|--------------------------------------------|

## 1.8 Disposal



When it has reached the end of its service life, please dispose of this product as electronic scrap in accordance with all applicable waste management laws.

## 1.9 EU declaration of conformity

Herewith we declare that the design and construction of this product and its identical variants, as well as the form brought onto the market by us, is in accordance with the relevant safety and health requirements of the EU Directive of Electromagnetic Compatibility 2014/30/EU. If alterations are made to the product without prior consultations with us, this declaration becomes invalid.

MAXI 3.0 job computer

Harmonised standards applied:

EN ISO 14982:2009

(EMC Directive 2014/30/EU)

MIDI 3.0 job computer

Harmonised standards applied:

EN ISO 14982:2009

(EMC Directive 2014/30/EU)

In conformity with further EU directives:

Directive 2011/65/EU (RoHS 2)

## 2 About these Operating Instructions

### 2.1 Who should read these instructions

These operating instructions are intended for operators of field sprayers that are equipped with the SPRAYER-Controller MAXI 3.0 or MIDI 3.0 system with the standard configuration.

The instructions will show you:

- The meaning of the icons on the screen;
- Where to find the settings that are relevant for a function in the application;
- How to configure the application;
- How to calibrate components that need to be calibrated.

The instructions do not explain how to operate the field sprayer. It is not a substitute for the field sprayer manufacturer's instruction manual.

### 2.2 Diagrams in this manual

The screenshots of the software interface are intended to serve as a reference. They help you in finding your way around the software screens.

The information shown on the screen depends on various factors:

- the implement type,
- the implement configuration,
- the implement status.

Possible differences:

- The implement has different colours on the terminal than in the instructions.
- Different background colour.
- The icons described in the instructions appear in a different position on the screen.
- Some of the described functions are not available in the system.

### 2.3 Directional information in these instructions

All directional information in these instructions, such as "left", "right", "forward", "back", is relative to the movement direction of the vehicle.

### 2.4 Layout of operating instructions

The operating instructions explain step by step how you can perform certain operations with the product.

We use the following symbols throughout these Operating Instructions to identify different operating instructions:

| Type of depiction | Meaning                                                               |
|-------------------|-----------------------------------------------------------------------|
| 1.<br>2.          | Actions that must be performed in succession.                         |
| ⇒                 | Result of the action.<br>This will happen when you perform an action. |

| Type of depiction | Meaning                                                                                                                       |
|-------------------|-------------------------------------------------------------------------------------------------------------------------------|
| ⇒                 | Result of an operating instruction.<br>This will happen when you have completed all steps.                                    |
| ☑                 | Requirements.<br>In the event that any requirements have been specified, these must be met before an action can be performed. |

## 2.5

### Layout of references

If any references are given in these Operating Instructions, they appear as:

Example of a reference: [→ 13]

References can be identified by their square brackets and an arrow. The number following the arrow shows you on what page the section starts where you can find further information.

## 3 About the job computer

### 3.1 Job computer functions

The SPRAYER-Controller MIDI 3.0 and MAXI 3.0 job computers are ISOBUS job computers that can control the operation of field sprayers.

The ISOBUS job computer is the control central of the sprayer. Several sensors are connected to the job computer, which monitor important implement parts. The job computer controls the implement based on these signals and on the operator's specifications. An ISOBUS terminal serves as an interface. All implement-specific data is stored in the job computer and is therefore maintained even when changing the terminal.

### 3.2 System Overview

Depending on which job computer is used as the base computer for the main system, and which additional components are installed, the overall system can have different sizes.

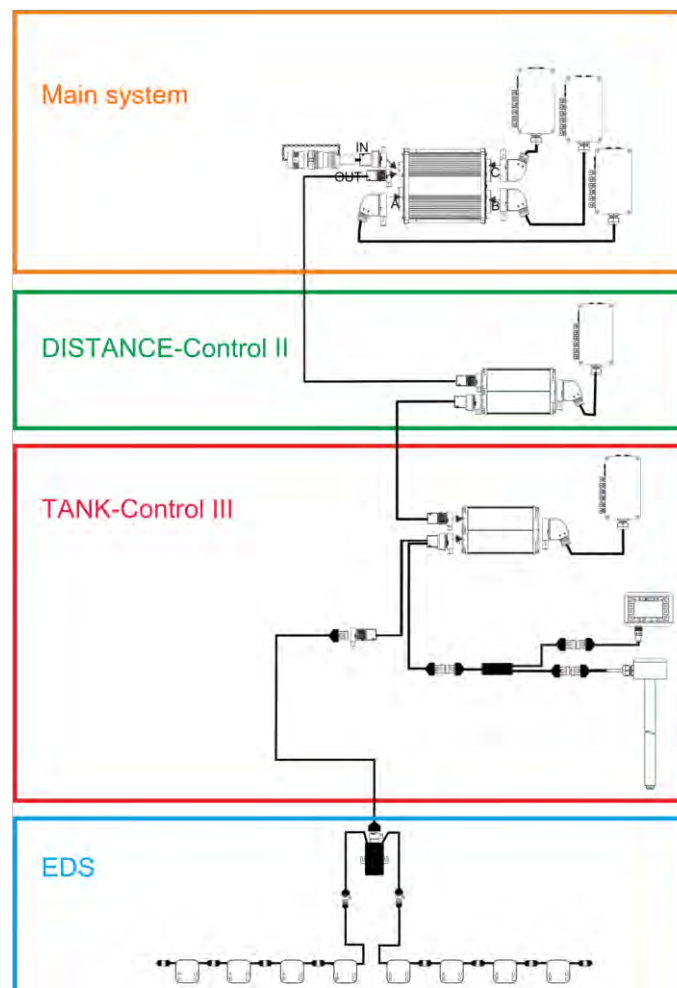

*Example: MAXI 3.0 as the main job computer*

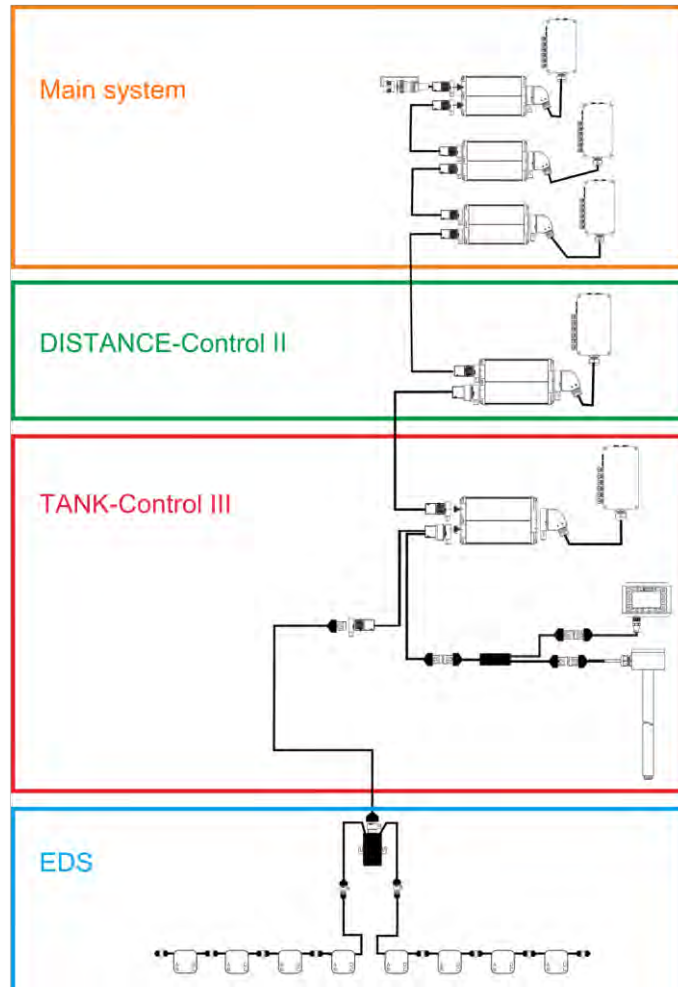

Example: MIDI 3.0 as the main job computer

### 3.2.1

#### Main system - MAXI

The system can be expanded. In the basic version, it consists of a job computer that is connected to the junction box and the ISOBUS power socket of the tractor.

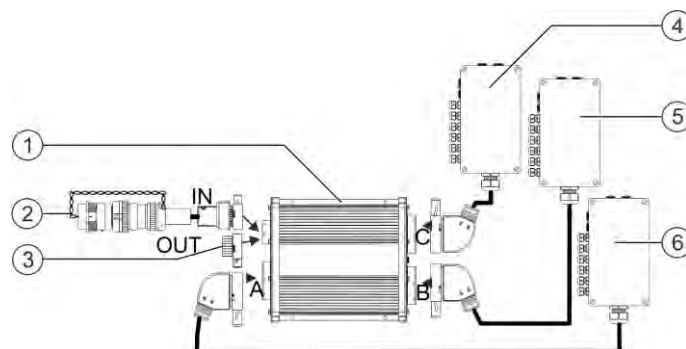

Main system - Version MAXI 3.0

|   |                                                                              |   |                |
|---|------------------------------------------------------------------------------|---|----------------|
| ① | ISOBUS SPRAYER-Controller MAXI 3.0 job computer                              | ④ | Junction box C |
| ② | Connector cable for job computer to ISOBUS Connection to ISOBUS power socket | ⑤ | Junction box B |
| ③ | Water and dust protection cap. Otherwise, connection of extensions.          | ⑥ | Junction box A |

3.2.2

Main system - MIDI

The system can be expanded. The basic version consists of one to three job computers. The first job computer is connected to the ISOBUS power socket on the tractor.

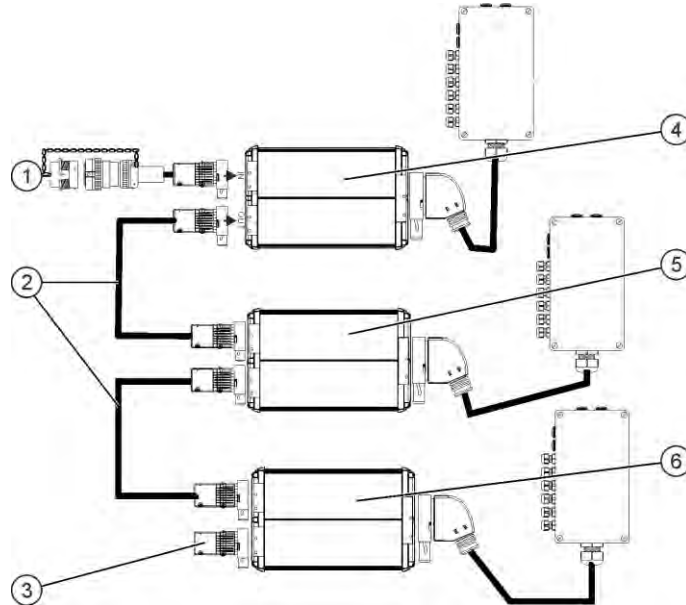

Main system of the MIDI 3.0 version

|   |                                                                                 |   |                   |
|---|---------------------------------------------------------------------------------|---|-------------------|
| ① | Connector cable for job computer to ISOBUS<br>Connection to ISOBUS power socket | ④ | ECU-MIDI - Master |
| ② | Connector cable                                                                 | ⑤ | ECU-MIDI - Slave  |
| ③ | Termination plug<br>Otherwise, connection of extensions.                        | ⑥ | ECU-MIDI - Slave  |

3.2.3

Extension: DISTANCE-Control II

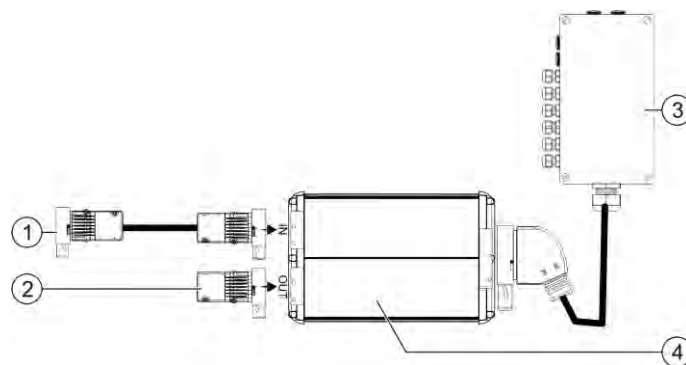

DISTANCE-Control II

|   |                                                                     |   |              |
|---|---------------------------------------------------------------------|---|--------------|
| ① | Connection to ECU-MAXI 3.0 or to the last<br>ECU-MIDI job computer. | ③ | Junction box |
| ② | Termination plug.<br>Otherwise, connection of other extensions.     | ④ | Job computer |

The instructions for the DISTANCE-Control II extension can be found in the download area of our website:

[www.mueller-elektronik.de](http://www.mueller-elektronik.de)



3.2.4

Extension: TANK-Control III

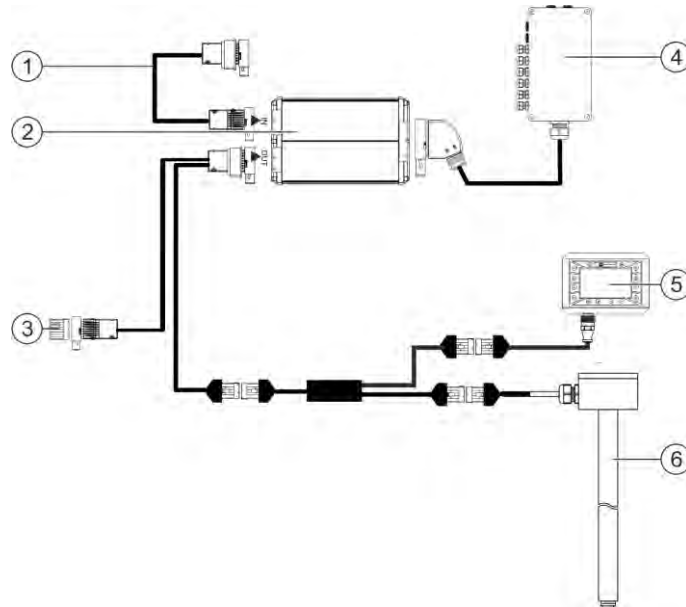

TANK-Control II

|   |                                                                                               |   |                                                         |
|---|-----------------------------------------------------------------------------------------------|---|---------------------------------------------------------|
| ① | Connection to the main system or to a system add-on                                           | ④ | Junction box                                            |
| ② | Job computer                                                                                  | ⑤ | TANK-Control III on-board integrated display/controller |
| ③ | Water and dust protection cap or terminating resistor.<br>Otherwise, connection of extensions | ⑥ | Fill level sensor                                       |

The instructions for the TANK-Control III extension can be found in the download area of our website:  
[www.mueller-elektronik.de](http://www.mueller-elektronik.de)

3.2.5

Extension: EDS

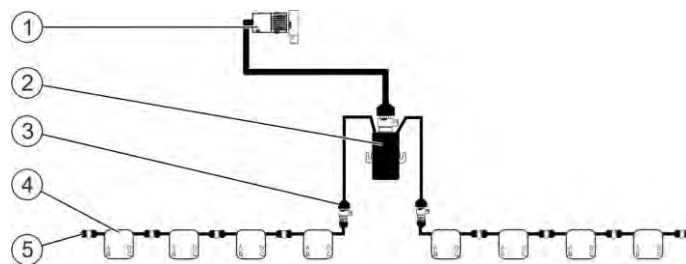

EDS

|   |                                                     |   |                  |
|---|-----------------------------------------------------|---|------------------|
| ① | Connection to the main system or to a system add-on | ④ | EDS modules      |
| ② | EDS communication module                            | ⑤ | Termination plug |
| ③ | Connection to the EDS bus                           |   |                  |

The instructions for the EDS extension can be found in the download area of our website:  
[www.mueller-elektronik.de](http://www.mueller-elektronik.de)

### 3.3 Software extensions

In addition to the functions that are configured as a standard, there are software extensions that can be additionally activated:

- TRAIL-Control
- DISTANCE-Control
- VARIO-Select

The instructions for the TRAIL-Control extension can be found in the download area of our website: [www.mueller-elektronik.de](http://www.mueller-elektronik.de)

The instructions for the DISTANCE-Control extension can be found in the download area of our website:

[www.mueller-elektronik.de](http://www.mueller-elektronik.de)

More information about VARIO-Select can be found in the EDS instructions. These instructions can also be found in the download area of our website:

[www.mueller-elektronik.de](http://www.mueller-elektronik.de)

### 3.4 Rating plate

Abbreviations on the rating plate

| Abbreviation   | Meaning                                                                                                                                                                      |
|----------------|------------------------------------------------------------------------------------------------------------------------------------------------------------------------------|
| <b>K.-Nr.:</b> | Customer number<br><br>If the product was manufactured for an agricultural machinery manufacturer, the agricultural machinery manufacturer's item number will be shown here. |
| <b>HW:</b>     | Hardware version                                                                                                                                                             |
| <b>ME-NR:</b>  | Müller-Elektronik item number                                                                                                                                                |
| <b>DC:</b>     | Operating voltage<br><br>The product may only be connected to voltages within this range.                                                                                    |
| <b>SW:</b>     | Software version upon delivery                                                                                                                                               |
| <b>SN:</b>     | Serial number                                                                                                                                                                |

## 4 Mounting and installation

### 4.1 Installing the job computer

#### 4.1.1 Instructions for safe installation



To prevent damage to the system components, consider the following during installation:

- Install the job computer where it is protected from dirt. You therefore avoid unintentional cleaning of the job computer by the implement operator using a high-pressure cleaner.
- In the installed position, the connectors and the pressure compensation membrane must be facing to the side.
- Fasten the job computer with four fixing bolts and a flat washer (lock washers can cause cracks in the plastic on the long term) on a conducting spot on the implement chassis. In case of improper installation, the ESD discharges can cause malfunctions.
- All of the sockets and connectors that are not used must be protected from dust and water using suitable dummy connectors.
- All of the connectors must be tightly sealed. This makes them waterproof.
- Do not use the system if some of its parts are damaged. Damaged parts can cause malfunctions and lead to injuries. Replace damaged components or repair them if possible.
- Only use original components.

#### 4.1.2 Connecting the AMP connectors

Procedure

This is how to connect two AMP connectors:

1. Pull out the red locking device of the AMP socket all the way to the end.



- ⇒ You will hear a loud clicking sound.
- ⇒ The openings for inserting the locking pins of the connector are visible.

2. Insert the connector into the socket. It should be possible to easily insert the locking pins in the openings.



- ⇒ The connector is loosely inserted in the socket.

3. Press in the red locking device.



- ⇒ You will hear a loud clicking sound.
- ⇒ A part of the locking device comes through to the other side of the socket.

⇒ You have connected and locked the connector with the socket.



### 4.1.3

#### Separating the AMP connectors

##### Procedure

This is how to separate two AMP connectors:

1. Press in both ends of the red locking device in direction of the connector.



⇒ You will hear a loud clicking sound.



⇒ The locking device has been released.

2. Pull out the red locking device of the AMP socket all the way to the end.
3. Pull the connector out of the socket.

## 4.2

### Connecting the job computer to the ISOBUS

To connect the job computer to the power supply and to the ISOBUS terminal, you have to connect the ISOBUS cable to an ISOBUS power socket on the tractor.

##### Procedure

This is how to connect the job computer to the ISOBUS:

1. Take the ISOBUS cable from the job computer.
2. Unscrew the dust protection cap.



⇒

3. Insert the ISOBUS connector into the ISOBUS power socket on the tractor.
4. Lock the connector. For basic vehicle harnesses from Müller-Elektronik, turn the connector clockwise. For other ISOBUS basic vehicle harnesses, the procedure depends on the model.
  - ⇒ The connector fits tightly.
5. Screw the dust protection cap of the connector and the socket together.



6. When the work is completed, separate the connection and screw the dust protection cap back on.



## 4.3 Installing the junction box

Take note of the following when selecting the installation location:

- Ensure that cables cannot be damaged by the moving implement.
- The cable glands must be facing downwards.

### 4.3.1 Connecting the sensors and actuators to the junction box

Every sensor and every actuator that is mentioned in the pin-out diagram must be connected to the connection in the junction box mentioned in the pin-out diagram.

This can be done in two ways:

- The sensor or actuator ends with a short cable and an AMP connector.  
In this case, you will receive a fitting extension cable for each sensor. You must insert the extension cable in the junction box and connect it to the fitting terminal.
- The sensor or actuator ends with a long cable without a connector. You have to insert it in the junction box and connect it to the fitting terminal.

The terminal to which you must connect the cable core depends on the respective implement and on the type of sensor or actuator.

Please note that the cable cores for the ultrasonic sensor trigger always need to be connected to Pins 2 and 3.

#### NOTICE

##### Risk of short-circuit

When exchanging the polarity of cable cores, machine sensors can be damaged by a short-circuit.

- Pay attention to the polarity of the cable cores and the terminals.

#### Procedure

- The junction box is not powered.
  - There is no voltage on the components to be connected.
1. Remove the cable coating so that all cable cores are exposed.

2. Insert the cable to the end of the coat. There should only be cable cores inside the junction box. The cable coating must end at the junction box casing. This is the only way to ensure that you have enough space in the junction box to be able to guide all of the cable cores to the terminals.
3. Remove the cable coating of the cable cores ca. 1 cm from the end of the cable core.
4. CAUTION! Pay attention to the proper polarity of the cable cores and the terminals.
5. Connect the cable cores to the terminals.  
To do so, use the information on the lid of the junction box, on the relay circuit board and in the pin-out diagram.
6. With screw terminals, use wire end sleeves. Wire end sleeves may not be used with spring-loaded terminal blocks.
7. Close the screw connections of the junction box.  
After screwing them shut, the glands should be sealed.
8. Close unused openings in the casing of the junction box with blind caps.

### 4.3.2

#### Inserting the cable core into a terminal

Each terminal consists of two openings:

- The upper opening of the terminal opens the lower opening.
- The bottom opening of the terminal serves to insert and clamp one cable core.

#### Procedure

- You have prepared a small flat screwdriver that fits the upper opening of the terminal. You only need this screwdriver if there are no wire end sleeves on the cable cores.
  - You have cut the cable to the proper length and have exposed the cable cores according to the instructions, or you have a finished cable from Müller Elektronik.
  - The tractor engine is switched off.
  - The junction box is not powered.
  - There is no voltage on the components to be connected.
1. Find the proper connectors for the cable cores to be connected.  
To do so, use the information on the lid of the junction box, on the relay circuit board and in the pin-out diagram.
  2. Insert the cable core into the opening in the lower part of the terminal. If you are not using wire end sleeves, you first have to use the screwdriver.
    - ⇒ The cable core will be held by the terminal.
    - ⇒ You have clamped the cable core.

### 4.3.3

#### Connecting the junction box to the job computer

#### Procedure

1. Connect the AMP connector of the junction box onto the proper job computer.

## 5 Basic control principles

### 5.1 Switching on the job computer

#### Procedure

1. Connect the ISOBUS cable of the job computer to the ISOBUS connector on the tractor.
2. Start the ISOBUS terminal.
  - ⇒ The job computer is started together with the terminal.
  - ⇒ When starting up for the first time, the job computer initially has to transmit lots of information to the terminal. This can take a few minutes.
  - ⇒ When all of the data from the job computer application has been loaded, their icon appears

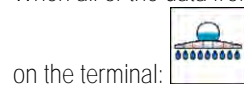

3. Open the job computer application. To do so, follow the instruction for the ISOBUS terminal.
  - ⇒ The work screen of the job computer appears.

### 5.2 Layout of work screen

The work screen is always shown during work and informs you of the status of the field sprayer.

The work screen is divided into several areas. In each area, information on specific topics may appear.

With the configuration of the job computer, the areas can be changed by the field sprayer manufacturer for a specific field sprayer model. For this reason, the following graphs only show the standard version of the overview.

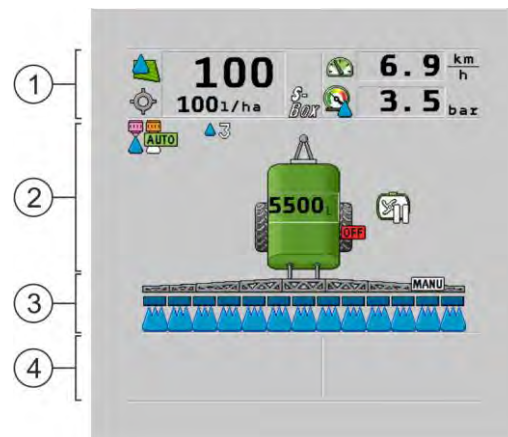











Areas on the work screen

|   |                            |   |                                  |
|---|----------------------------|---|----------------------------------|
| ① | "Spray data" area          | ③ | "Boom" area                      |
| ② | Implement image with icons | ④ | Icons beside the implement image |

You can read about the information that appears in these areas in the following sections.

Function icons appear beside the work screen, which perform functions when they are tapped. Their position and operation depend on the type of ISOBUS terminal.



In the table below, you can see the meaning of the function icons on the work screen.

| Function icon                                                                       | Function                                                                           |
|-------------------------------------------------------------------------------------|------------------------------------------------------------------------------------|
|    | Opens the "Results" screen.                                                        |
|    | Opens the "Parameters" screen.                                                     |
|    | Opens the "Tank Filling" screen.                                                   |
|    | Opens the "Folding" screen.                                                        |
|    | Switches between manual and automatic regulation of the application rate.          |
|    | Opens a screen with additional functions.                                          |
|    | Starts and stops the drawbar or axle steering.                                     |
|   | Switches between two levels of icons.                                              |
|  | Switches between two levels of icons, if an additional water sensor is configured. |
|  | Shows the next page with function icons.                                           |













## 5.2.1

## Spray data area

Depending on the configuration, the following icons may appear:

| Icon                                                                                | Meaning                                                                                                                                                                                                                                                                                                                          |
|-------------------------------------------------------------------------------------|----------------------------------------------------------------------------------------------------------------------------------------------------------------------------------------------------------------------------------------------------------------------------------------------------------------------------------|
|  | <p>The application rate will be automatically regulated.</p> <p>An additional number can appear on the icon. This number indicates the pre-set density.</p> <p>The current value (current application rate) appears next to it.</p>                                                                                              |
|  | <p>No flow. The main valve cannot be opened because one of the requirements has not been fulfilled:</p> <ul style="list-style-type: none"> <li>- Speed slower than "Sprayer off below" [→ 57]</li> <li>- Section status</li> <li>- Target rate out of reach</li> <li>- SECTION-Control has terminated the application</li> </ul> |
|  | <p>The application rate will be automatically regulated.</p> <p>The target rate appears next to it.</p>                                                                                                                                                                                                                          |



| Icon                                                                                                            | Meaning                                                                                                                                                                                                                                                                                                 |
|-----------------------------------------------------------------------------------------------------------------|---------------------------------------------------------------------------------------------------------------------------------------------------------------------------------------------------------------------------------------------------------------------------------------------------------|
|                                                                                                                 | See: Using Automatic mode [→ 44]                                                                                                                                                                                                                                                                        |
|                                | The application rate will be manually regulated.<br>See: Changing the application rate in manual mode [→ 44]                                                                                                                                                                                            |
|                                | The bar graph only appears when the target rate is changed in automatic mode using the +10% and -10% buttons. It shows the deviation from the original target rate.                                                                                                                                     |
|                                | Automatic mode is deactivated. The flow will not be regulated.<br>The current speed is lower than the "Regulation off below" [→ 57] parameter and higher than "Sprayer off below" [→ 57]                                                                                                                |
|                                | The target rate is defined by an external source: Task Controller, prescription map, external sensor etc. See: Setting target rate [→ 46]                                                                                                                                                               |
|                                | - A problem has occurred with the transmission of the target rate from an external source.<br>- The sprayer is outside of the area defined in the prescription map or in an area that should not be sprayed.                                                                                            |
|                              | The sprayer functions will be switched on and off through an "S-Box".                                                                                                                                                                                                                                   |
|                              | Trip counter is deactivated<br>See: Documenting work results [→ 47]                                                                                                                                                                                                                                     |
|                              | Speed<br>If the numbers are red, it means that the regulation or the application have been interrupted because the speed is too low.                                                                                                                                                                    |
| <br>(background is flashing) | The speed signal from the tractor / ISOBUS cannot be adopted. The system will now determine the speed using the sensor connected to the junction box.<br>Ensure that the number of impulses per 100m is correctly entered.<br>The icon can only appear if the signal source was automatically selected. |
|                              | The vehicle is driving in reverse.                                                                                                                                                                                                                                                                      |
|                              | Simulated speed activated. [→ 68]                                                                                                                                                                                                                                                                       |
|                              | Pressure<br>Per default, the pressure is determined by a pressure sensor. If there is no pressure sensor, a calculated pressure can be shown.                                                                                                                                                           |

| Icon | Meaning                                                                                                  |
|------|----------------------------------------------------------------------------------------------------------|
|      | The pressure measured by the pressure sensor is too low compared to the flow measured by the flow meter. |
|      | Pressure control is active.                                                                              |

5.2.2

Boom display area

In the boom display you find the following information:

- Number of sections
- Which sections are preselected or switched off
- Which sections are applying

Illustration

The diagrams below show how the sections may appear in the boom display area:

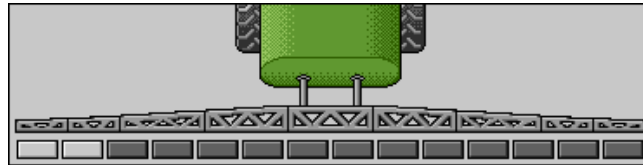

Sections 1 and 2 are closed and deactivated.

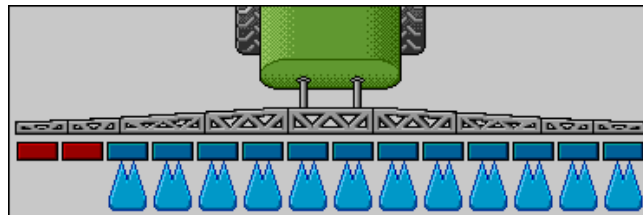

Sections 1 and 2 are closed. All of the other sections are open and spraying.

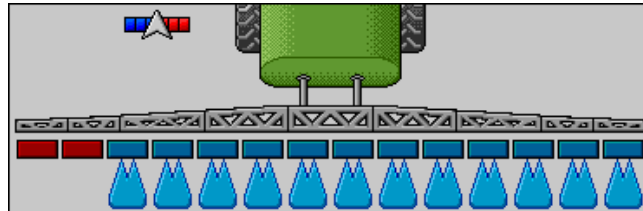

When SECTION-Control is activated, the SECTION-Control icon also appears.

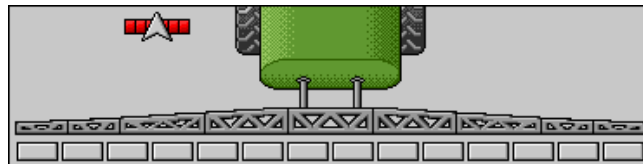





If SECTION-Control is not possible, the colour of the SECTION-Control icon changes.

Each rectangle corresponds to a section valve.



Section status

| Picture | Status of the section valve | Status of the control/main valve |
|---------|-----------------------------|----------------------------------|
|         | Closed valve                | Closed valve                     |

| Picture                                                                           | Status of the section valve            | Status of the control/main valve |
|-----------------------------------------------------------------------------------|----------------------------------------|----------------------------------|
|  | Opened valve                           | Closed valve                     |
|  | Opened valve                           | Opened valve                     |
|  | Closed valve                           | Opened valve                     |
|  | The section is permanently deactivated |                                  |

When the sections are automatically switched using SECTION-Control, you have to ensure that the sections are not deactivated using an S-Box or a joystick. In this case, the section would be marked with a red cross and remain closed.

Section status with SECTION-Control and with S-Box

| Picture                                                                             | Status defined by SECTION-Control | Status of the control/main valve | Status via S-Box or joystick |
|-------------------------------------------------------------------------------------|-----------------------------------|----------------------------------|------------------------------|
|  | Opened valve                      | Opened valve                     | Closed valve                 |
|  | Opened/closed valve               | Closed valve                     | Closed valve                 |

Field sprayers with EDS (single nozzle switching) do not have section valves. One section consists of multiple nozzles that are switched by EDS modules. The section icon is divided into several segments. Each segment represents one nozzle.



Section status with EDS















| Picture                                                                             | Nozzle A    | Nozzles B, C, D |
|-------------------------------------------------------------------------------------|-------------|-----------------|
|  | Open nozzle | Closed nozzle   |

















### 5.2.3

### Icons beside the implement image







#### Functions

| Icon                                                                                | Meaning                                                                                                                                                                                                   |
|-------------------------------------------------------------------------------------|-----------------------------------------------------------------------------------------------------------------------------------------------------------------------------------------------------------|
|  | Sections are switched via SECTION-Control.                                                                                                                                                                |
|  | The SECTION-Control application has closed all sections.<br>Examples for the cause: <ul style="list-style-type: none"> <li>The sprayer is outside of the field boundary or in an area that has</li> </ul> |







| Icon                                                                                             | Meaning                                                                                                                                       |
|--------------------------------------------------------------------------------------------------|-----------------------------------------------------------------------------------------------------------------------------------------------|
|                                                                                                  | <p>already been worked</p> <ul style="list-style-type: none"> <li>▪ Sprayer on the headland</li> </ul> <p>Other causes are also possible.</p> |
|                 | Beacon is switched on.                                                                                                                        |
|                 | The working lights are switched on.                                                                                                           |
|                 | Nozzle lighting is switched on.                                                                                                               |
|  (flashing)     | Stirrer has been stopped. Cause: Fill level [→ 58] is too low.                                                                                |
|  (not flashing) | Stirrer has been stopped. Cause: Stopped by the driver.                                                                                       |
|                | Stirrer is working.                                                                                                                           |
|               | Fresh water is being filled into the main tank.                                                                                               |
|               | Fresh water is being transferred.                                                                                                             |
|               | Tank internal cleaning is activated.                                                                                                          |
|               | Low-pressure cleaner is being used.                                                                                                           |
|               | High-pressure cleaner is being used.                                                                                                          |
|               | The ring line is being rinsed.                                                                                                                |
|               | Mixing hopper is being lifted.                                                                                                                |
|               | Mixing hopper is being lowered.                                                                                                               |
|               | Nozzles used in Vario mode.                                                                                                                   |

| Icon                                                                                | Meaning                                                                                           |
|-------------------------------------------------------------------------------------|---------------------------------------------------------------------------------------------------|
|    | Nozzles used in Select mode.                                                                      |
|    | Nozzle cleaning activated.                                                                        |
|    | Intended drop size with Airtec or in Vario mode.                                                  |
|    | Pump switched on.                                                                                 |
|    | Pump switched off.                                                                                |
|    | Fan switched on.                                                                                  |
|    | Fan switched off.                                                                                 |
|   | Permanent tank internal cleaning is activated.                                                    |
|  | Filter rinsing is activated.                                                                      |
|  | Filter rinsing is activated and being used.                                                       |
|  | Compressed air rinsing is being used.                                                             |
|  | The support leg is being lowered.                                                                 |
|  | The support leg is being raised.                                                                  |
|  | The corresponding unit of the Raven injection system is active.                                   |
|  | The corresponding unit of the Raven injection system is deactivated.                              |
|  | The corresponding unit of the Raven injection system is not connected or not ready for operation. |
|  | CURVE-Control is activated.                                                                       |

## Airtec icons



| Icon                                                                               | Meaning                                                       |
|------------------------------------------------------------------------------------|---------------------------------------------------------------|
|   | Current air pressure                                          |
|   | System is increasing the air pressure.                        |
|   | System is reducing the air pressure.                          |
|   | Air compressor is off.                                        |
|   | Air compressor is on.                                         |
|   | Manual mode is activated. The number indicates the drop size. |
|  | Drop size (automatic mode activated).                         |

## Counters and sensors

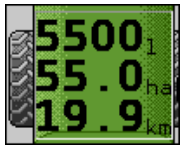

| Icon                                                                                | Meaning                                                                                                               |
|-------------------------------------------------------------------------------------|-----------------------------------------------------------------------------------------------------------------------|
|  | Wind strength                                                                                                         |
|  | Output in litres per minute                                                                                           |
|  | Area output per hour                                                                                                  |
|  | The output per minute measured by the flow meter is too low compared to the output calculated by the pressure sensor. |
|  | Fan speed                                                                                                             |
|  | Pump speed<br>Can also be used to indicate whether a pump is switched on or off.                                      |

## 5.2.4 Icons on the implement image









### General icons

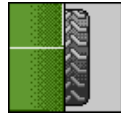



| Icon                                                                              | Meaning                                                                                                                                                                                                                                                                       |
|-----------------------------------------------------------------------------------|-------------------------------------------------------------------------------------------------------------------------------------------------------------------------------------------------------------------------------------------------------------------------------|
|  | <p>Tank counter:</p> <ul style="list-style-type: none"> <li>▪ Current fill level (l)</li> <li>▪ Area that can be sprayed until the tank is empty (ha)</li> <li>▪ Distance that can be driven until the tank is empty (km)</li> <li>▪ Acid content in the tank (pH)</li> </ul> |
|  | Ring line circulation function switched on.                                                                                                                                                                                                                                   |

### Boom

| Icon                                                                                | Meaning                                                                                                 |
|-------------------------------------------------------------------------------------|---------------------------------------------------------------------------------------------------------|
|    | <p>DISTANCE-Control is installed but is deactivated.</p> <p>The boom has to be controlled manually.</p> |
|  | Display of the current boom slope. See: Reproducing the boom slope when turning [→ 40]                  |

### TRAIL-Control

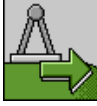
| Meaning                                        | Icons for drawbar steering                                                          | Icons for axle steering                                                               |
|------------------------------------------------|-------------------------------------------------------------------------------------|---------------------------------------------------------------------------------------|
| No TRAIL-Control.                              |  |  |
| TRAIL-Control is installed but is deactivated. |  |  |
| TRAIL-Control is in manual mode.               |  |  |
| TRAIL-Control is in automatic mode.            |  |  |
| The drawbar is locked with a pin               |  |                                                                                       |

| Meaning                                      | Icons for drawbar steering                                                        | Icons for axle steering                                                             |
|----------------------------------------------|-----------------------------------------------------------------------------------|-------------------------------------------------------------------------------------|
| The implement is being steered to the left.  |  |  |
| The implement is being steered to the right. |  |  |

## 5.3

## Control units

The following options are available for operating the job computer:

- Using the function buttons on the screen
- Using AUX-N operating devices
- Using the ME joystick
- Using the ME S-Box
- Using an external keypad

You can find more information on the configuration and operation in the following sections:

- Configuring the control units [→ 59]
- Operating the ME joystick [→ 49]
- Viewing the assignment of the joystick [→ 50]
- Preview mode for the ME Joystick [→ 49]



## 6 Operating job computer on the field

### 6.1 Tank filling

After each filling, you can enter how much liquid you added to the tank.

#### Methods



Depending on what additional equipment is fitted to your sprayer, the procedure may be different.

In doing so, you can:

- Fill up the tank manually without additional systems
- Fill up the tank with TANK-Control
- Fill up the tank with TANK-Control and with a fill stop

#### 6.1.1 Filling up the tank manually without additional systems

If you fill up the tank manually without any additional systems, you can enter the new tank content manually on the terminal.

| Function icon                                                                      | Function                       |
|------------------------------------------------------------------------------------|--------------------------------|
|   | Tank is being fully filled up. |
|  | Set tank content to 0 litre.   |

#### Procedure

To enter the new tank content when you have completely refilled the spray liquid tank:

1. Switch to the "Filling - manual" screen:



⇒ The following screen appears:

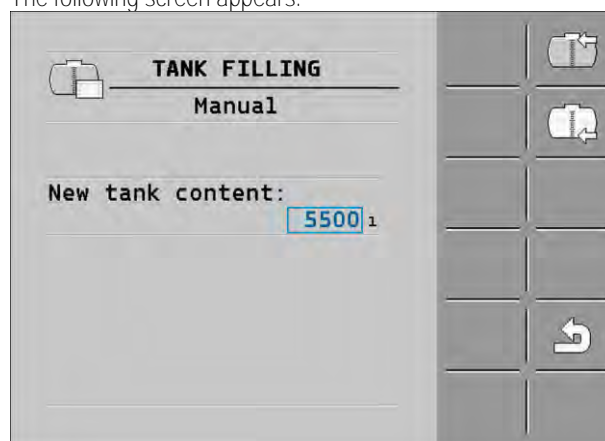

2.  - Enter full tank  
or

3. In the "New tank content" box, enter the tank content after refilling.

⇒ The new tank content appears in the work screen, in the tank data area.

#### 6.1.2 Filling up the tank with TANK-Control

TANK-Control is a measurement system that constantly measures and displays the tank content.

## Procedure

1. Switch to the "Filling - TANK-Control" screen:



2.  - Start filling.

⇒ During the filling procedure, the following icon appears on the screen:



⇒ While filling is taking place, the filled quantity appears on the "Filling - TANK-Control" screen on the "Current content" line.





3.  - When the tank is full, switch off pump.

## 6.1.3

## Filling up the tank with TANK-Control and fill stop

If a TANK-Control with fill stop has been installed and configured on the sprayer, you can use it. It will stop tank filling automatically when a specified fill level is reached.

You can define up to two refilling limits for tank filling. The system stops filling the tank when the tank content reaches these refilling limits.

| Function icon                                                                       | Function                          | Results                                                                                                                                                                                                                                                                                                      |
|-------------------------------------------------------------------------------------|-----------------------------------|--------------------------------------------------------------------------------------------------------------------------------------------------------------------------------------------------------------------------------------------------------------------------------------------------------------|
|  | Open ball valve for tank filling  | <ul style="list-style-type: none"> <li>▪ Ball valve is being opened.</li> <li>▪ The following icon appears on the screen: </li> <li>▪ Water is being pumped.</li> <li>▪ Current tank content changes slowly.</li> </ul> |
|  | Close ball valve for tank filling | <ul style="list-style-type: none"> <li>▪ Ball valve is being closed.</li> </ul>                                                                                                                                                                                                                              |
|  | Change active refill limit        | <ul style="list-style-type: none"> <li>▪ Only the selected refilling limit is taken into account while pumping. The tank is filled until the fill level is reached.</li> </ul>                                                                                                                               |

## Procedure

To fill the tank with two refilling limits:

- TANK-Control with fill stop is installed on the sprayer.

1. Switch to the "Tank filling - TANK-Control" screen:



⇒ The following screen appears:

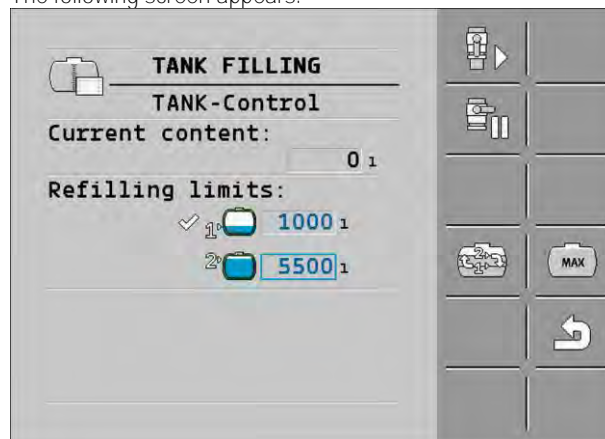

2. For refilling limit 1 and 2, you can enter up to two fill levels at which the filling pump should be stopped or the filling ball valve should be closed.

⇒ If you enter two refilling limits, a new function icon appears on the screen:



⇒ Press the  icon to mark a refilling limit at which the pump should be stopped.

3.  - Open the ball valve.

⇒ The  icon appears.

⇒ Filling starts.

⇒ When the fill level defined as refilling limit 1 is reached, the ball valve closes and filling is terminated.

⇒ If there is a second refilling limit, it will be automatically activated.

4. You can now add the spray agent and stir the tank contents.

5. Prepare the sprayer for the second filling.

6.  - Open the ball valve.



⇒ Filling starts.

⇒ When the fill level defined as refilling limit 2 is reached, the ball valve closes and filling is terminated.

## 6.2

## Controlling the boom

In this section you learn how to control the boom using the terminal.

|                                                                                     |                                                                                                                                                                                                                                                                                                                                                                                                                  |
|-------------------------------------------------------------------------------------|------------------------------------------------------------------------------------------------------------------------------------------------------------------------------------------------------------------------------------------------------------------------------------------------------------------------------------------------------------------------------------------------------------------|
|  |  <b>WARNING</b>                                                                                                                                                                                                                                                                                                               |
|                                                                                     | <p>Injury to persons through improper operation<br/>Every field sprayer is designed differently and must be operated differently. In this section, only the icons that appear on the screen of the terminal can be explained.</p> <ul style="list-style-type: none"> <li>◦ Read the field sprayer operating guide.</li> <li>◦ Learn the sequence in which your field sprayer must be operated safely.</li> </ul> |



## 6.2.1 Lifting and lowering the boom

Path This is how you reach the screen with this function:



To operate this function the user needs the ME joystick first of all.

Use the following function keys to operate the function:

| Function icon                                                                     | Function                                    |
|-----------------------------------------------------------------------------------|---------------------------------------------|
|  | Lifts the boom.                             |
|  | Lowers the boom.                            |
|  | Activates and deactivates DISTANCE-Control. |

Illustration

On the following diagram you see how this function is shown on the work screen:

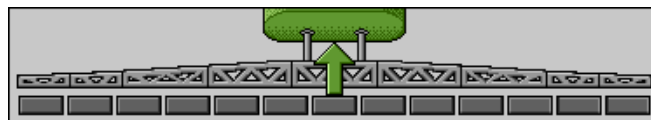

*Boom is being lifted - the arrow in the middle shows the direction*

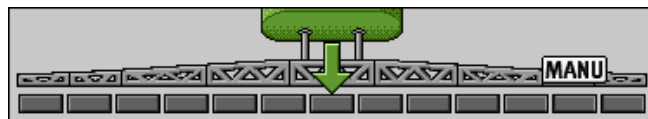

*"MANU" means that DISTANCE-Control is deactivated and the boom must be raised and lowered manually.*

## 6.2.2 Folding and unfolding the boom

This function folds the field sprayer boom in and out.

Operation depends on the following factors:

- Number of boom parts that can be folded in and out.
- Type of locking for the folding in and out of the boom.
- Type of field sprayer.

Path This is how you reach the screen with this function:



Structure of a boom

The following diagram shows the structure of booms and what the individual boom parts are called. The diagram shows a field sprayer with a seven-part boom, but it also applies to smaller booms.

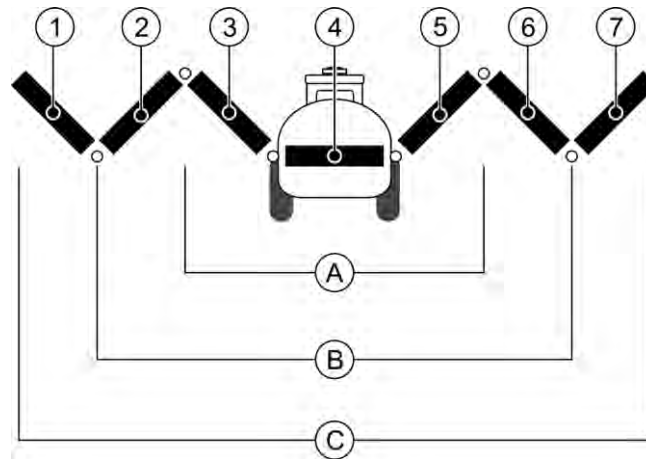

Parts of the boom on a field sprayer

|          |                        |          |                          |
|----------|------------------------|----------|--------------------------|
| <b>A</b> | Three-section boom     | <b>3</b> | Boom part: Inner left    |
| <b>B</b> | Five-section boom      | <b>4</b> | Boom part: Unmoving part |
| <b>C</b> | Seven-section boom     | <b>5</b> | Boom part: Inner right   |
| <b>1</b> | Boom part: Outer left  | <b>6</b> | Boom part: Middle right  |
| <b>2</b> | Boom part: Middle left | <b>7</b> | Boom part: Outer right   |

Illustration

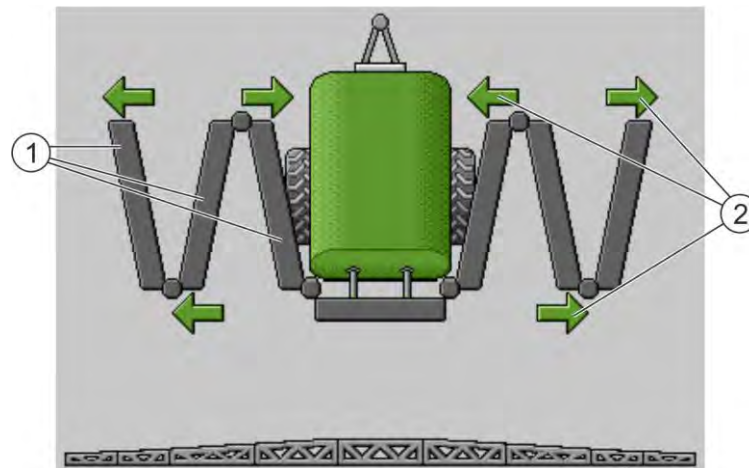

Representation of the boom on the "Boom folding" screen

|          |                                                                                                                                     |
|----------|-------------------------------------------------------------------------------------------------------------------------------------|
| <b>1</b> | Folding parts of the boom                                                                                                           |
| <b>2</b> | Icon: Boom section is being folded in or out<br>The arrows appear for folding boom sections and indicate the direction of movement. |

| Icon | Meaning                                                                                                             |
|------|---------------------------------------------------------------------------------------------------------------------|
|      | The boom is at the same height as the boom top height sensor. Requirement: The boom top height sensor is installed. |

Function icons

On the following diagram, you see how a seven-part boom is shown on the function icons.

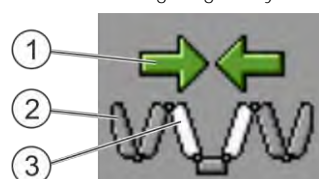

|   |                                                                                                       |
|---|-------------------------------------------------------------------------------------------------------|
| ① | Directional arrow<br>Arrow pointing inwards means: Fold in<br>Arrow pointing outwards means: Fold out |
| ② | Sections of the boom marked in grey are not folded in or out with this function icon                  |
| ③ | Sections of the boom marked in white are folded in or out with this function icon                     |

Use the following function keys to operate the function:

| Function                                   | Three-section boom                                                                  | Five-section boom                                                                     | Seven-section boom                                                                    |
|--------------------------------------------|-------------------------------------------------------------------------------------|---------------------------------------------------------------------------------------|---------------------------------------------------------------------------------------|
| Fold inner boom symmetrically              |    |    |    |
| Unfold inner boom symmetrically            |    |    |    |
| Fold boom in the middle symmetrically      |                                                                                     |    |    |
| Unfold boom in the middle symmetrically    |                                                                                     |    |    |
| Unfold outer left boom                     |                                                                                     |                                                                                       |   |
| Unfold outer right boom                    |                                                                                     |                                                                                       |  |
| Fold inner and middle boom symmetrically   |                                                                                     |  |                                                                                       |
| Unfold inner and middle boom symmetrically |                                                                                     |  |                                                                                       |
| Block boom section                         |  |   |  |

### 6.2.3

#### Locking the boom

This function enables locking and unlocking of the boom.

Path





This is how you reach the screen with this function:



Use the following function keys to operate the function:

| Function icon                                                                       | Meaning         |
|-------------------------------------------------------------------------------------|-----------------|
|  | Locks the boom. |

| Function icon                                                                     | Meaning           |
|-----------------------------------------------------------------------------------|-------------------|
|  | Unlocks the boom. |

| Icon                                                                              | Meaning                                                     |
|-----------------------------------------------------------------------------------|-------------------------------------------------------------|
|  | The boom is being locked. The procedure is not completed.   |
|  | The boom is being unlocked. The procedure is not completed. |
|  | The boom is locked.                                         |
|  | The boom is unlocked.                                       |

## 6.2.4 Raising and lowering the wings (tilting up / down)







The system is capable of raising or lowering wings independently or simultaneously.

Path

This is how you reach the screen with this function:



Use the following function keys to operate the function:

| Function icon                                                                       | Function                         |
|-------------------------------------------------------------------------------------|----------------------------------|
|  | Raises the right wing.           |
|  | Raises the left wing.            |
|  | Lowers the right wing.           |
|  | Lowers the left wing.            |
|  | Raises both wings symmetrically. |
|  | Lowers both wings symmetrically. |

Procedure

1. Press the function key with the desired function.  
⇒ The wings will be moved.
2. Keep function button pressed until the boom reaches the desired angle.
3. Release function key.



## 6.2.5 Sloping the boom

Path This is how you reach the screen with this function:



To operate this function the user needs the ME joystick first of all.

Use the following function keys to operate the function:

| Function icon                                                                     | Function                                                     |
|-----------------------------------------------------------------------------------|--------------------------------------------------------------|
|  | Slopes the boom to the right. It will be raised on the left. |
|  | Slopes the boom to the left. It will be raised on the right. |

Illustration

On the following diagram you see how this function is shown on the work screen:

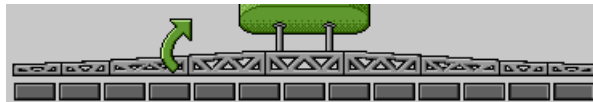

*Slope boom: raise on the left, lower on the right*

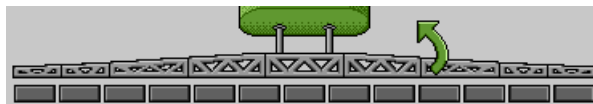

*Slope boom: lower on the left, raise on the right*

## 6.2.6 Reproducing the boom slope when turning

This function assists you when working on slopes.

Mode of operation

The boom is sloped when working on a hillside. The function saves the angle of slope.

After a turning manoeuvre, the angle of slope is reproduced when the field sprayer is travelling in the opposite direction.

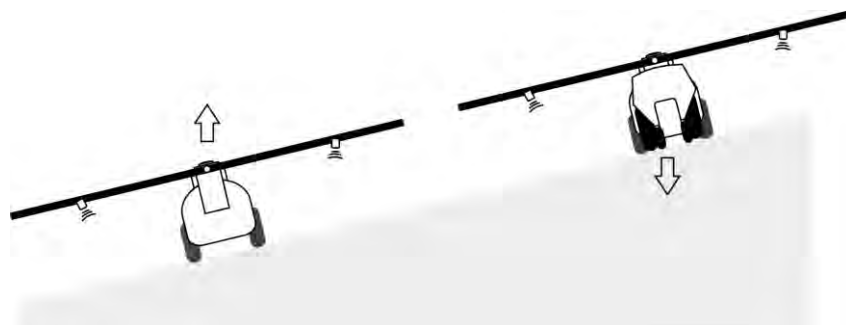

*When turning on a slope, you can press a button to slope the boom in the opposite direction.*

Use the following function keys to operate the function:

| Function icon                                                                       | Meaning                                                                                                          |
|-------------------------------------------------------------------------------------|------------------------------------------------------------------------------------------------------------------|
|  | Activates the function. Each time the button is pressed, the target position of the boom (white arrows) changes. |



| Function icon                                                                     | Meaning                                                                                                         |
|-----------------------------------------------------------------------------------|-----------------------------------------------------------------------------------------------------------------|
|  | Slopes the boom manually. By pressing this button, the automatic reproduction of the slope angle is terminated. |

Illustration



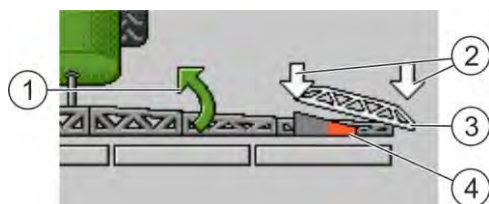

When the function is active, the current setting is shown above the boom on the work screen.

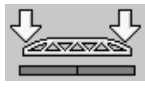

|   |                                            |   |                                                            |
|---|--------------------------------------------|---|------------------------------------------------------------|
| ① | Current direction of movement of the boom. | ③ | Current boom position.                                     |
| ② | Target boom position.                      | ④ | Current angle of the angle sensor on the sloping cylinder. |

Depending on the configuration, the following icons may appear:

Examples:

| Icon                                                                                | Meaning                                                                                                                                                                                                                                                           |
|-------------------------------------------------------------------------------------|-------------------------------------------------------------------------------------------------------------------------------------------------------------------------------------------------------------------------------------------------------------------|
|   | White arrows: Target position is horizontal.<br>Angle sensor: Horizontal position has been reached.                                                                                                                                                               |
|  | Boom is sloped to the right. Function is deactivated.                                                                                                                                                                                                             |
|  | Boom is sloped to the right. However, it should be automatically sloped to the left. The system will move the boom in this direction.<br>Current position: Boom is sloped to the right<br>Target position: Sloped to the left.<br>Reproduce boom angle: activated |
|  | Boom is sloped to the right. However, it should be automatically moved to a horizontal position. The system will move the boom in this direction.                                                                                                                 |

Procedure

- You have calibrated the boom potentiometer (slope angle sensor). [→ 79]

1. Drive across the slope gradient with the field sprayer.
2. Position the boom parallel to the sloped ground.

3.  – Press on the headlands before the turning manoeuvre.

⇒ The current angle will be saved.

⇒  - Two white arrows pointing down appear.

⇒ The system returns the boom to the horizontal position.

⇒ While the boom is moving, a green arrow appears on the work screen.

⇒ When the boom is horizontal, the  icon appears.

4. Turn only when the boom is horizontal.



5. - Press once after the turning manoeuvre.

⇒ The job computer slopes the boom in the opposite direction until the previously saved angle is reached on the other side.



⇒ While the boom is moving, a green arrow appears on the work screen.

⇒ The function switches off if you change the boom angle manually.

### 6.2.7

### Using additional boom sensors

If you are using additional boom sensors and these sensors detect a specific state, this will be shown on the work screen.

| Icon                                                                              | Meaning                                                                                    |
|-----------------------------------------------------------------------------------|--------------------------------------------------------------------------------------------|
|  | Boom height                                                                                |
|  | Transport position                                                                         |
|  | Slope middle position                                                                      |
| No icon on the work screen.                                                       | Boom folded – This sensor deactivates sections when a pre-set position has been reached.   |
| No icon on the work screen.                                                       | Boom unfolded – This sensor deactivates sections when a pre-set position has been reached. |

### 6.3

### Starting application

#### Procedure

To start the application:

- The tractor with the field sprayer is on the field.
- You have configured the job computer.
- You have folded out the boom.

1. Ensure that all prerequisites have been fulfilled.



2. - Start application

⇒ In manual mode:

The field sprayer starts the application.

⇒ In automatic mode:

The sprayer will be prepared for application.

As long as the sprayer is not moving, the following icon appears on the work screen,

depending on the “Sprayer off below:” parameter: 

3. If you are in automatic mode, start driving and exceed the minimum speed for the automatic regulation (parameter: “Regulation off below”).

⇒ As long as the field sprayer is not regulating, the following icon appears on the work screen,



depending on the “Regulation off below:” parameter:

⇒ As soon as the minimum speed is exceeded, the field sprayer starts regulating.

⇒ You have started application.

### Immediate application

There may be situations where you want to start spraying while the sprayer is still at a standstill. For example, when you have stopped on the field.

To start immediate application in automatic mode:

- The tractor with the field sprayer is on the field.
- You have configured the job computer.
- You have folded out the boom.
- Automatic mode is activated.

1. Press and hold the application button on the joystick for three seconds.

⇒ The field sprayer starts the application.

Spray cones appear under the boom icon:

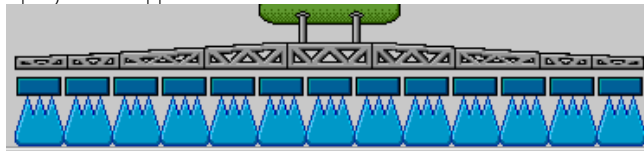

2. Start driving within 5 seconds and exceed the minimum speed for the automatic regulation (parameter: “Sprayer off below”). Otherwise, the application will be automatically terminated.

## 6.4

### Regulating the application rate

#### Types of regulation

Depending on the sprayer equipment, the application rate regulation system can either control the opening of a control valve or the speed of a centrifugal pump.

#### Work modes

You can regulate the application rate manually or you can leave the regulation to the job computer:

- In manual mode, you can control the opening of the control valve with two buttons.
- In automatic mode, the job computer regulates the opening of the control valve (or the pump speed) such that the application rate defined as the set rate is reached.

Use the following function keys to operate the function:

| Function icon                                                                       | Function                                        |
|-------------------------------------------------------------------------------------|-------------------------------------------------|
|  | Switches the mode between manual and automatic. |

You will learn how to operate the system in the following sections.

### 6.4.1 Changing the application rate in manual mode

When the field sprayer is in manual mode, the application is not regulated according to a specified rate. The application rate must be set manually instead.

The application rate must be regulated manually when the following icon appears in the spray data area of the work screen:



Application in manual mode

Please note that the pressure is also automatically changed when you change the application rate.

To operate this function the user needs the ME joystick first of all.

Use the following function keys to operate the function:

| Function icon | Function                        |
|---------------|---------------------------------|
|               | Increases the application rate. |
|               | Reduces the application rate.   |

### 6.4.2 Using Automatic mode

In automatic mode, the job computer regulates the degree of opening of the control valve and the main valve on the manifold such that the target rate defined for the application rate can be reached.

You are in automatic mode when one of the following icons appears in the spray data area of the work screen:

| Icon on the work screen | Meaning                                                                                                                                                                                           |
|-------------------------|---------------------------------------------------------------------------------------------------------------------------------------------------------------------------------------------------|
|                         | Sprayer can apply.                                                                                                                                                                                |
|                         | The speed of the sprayer is lower than "Regulation off below"<br>Sprayer can apply. The flow will not be regulated. The control valve remains in the last known position until the speed changes. |
|                         | The speed of the sprayer is lower than "Sprayer off below"<br>The main valve is closed automatically.                                                                                             |
|                         | Regulation is not possible because the application was deactivated by the SECTION-Control app.                                                                                                    |

#### Requirements

To use automatic mode, the following conditions must be fulfilled:

- Target rate has been entered.

- Flow meter is calibrated.
- A speed signal is available.
- Working width is set.
- The speed of the field sprayer is higher than the speed for the “Regulation off below” parameter.
- The parameter “Regul. factor” has been set.

Mode of operation





In the following cases, the flow is automatically adjusted:



- Speed of the sprayer has changed.
- Number of switched-on sections has changed.
- You have changed the target rate manually.
- The application rate has been changed by the information from the application map.

The speed and precision of the regulation depends on the value of the “Regul. factor” parameter.

You can change the target rate manually while driving in Automatic mode.

To operate this function the user needs the ME joystick first of all.

| Function icon                                                                       | Function                               |
|-------------------------------------------------------------------------------------|----------------------------------------|
|    | Increases the target rate by 10%.      |
|    | Reduces the target rate by 10%.        |
|  | Restores the target rate back to 100%. |
|  | Changes to the entered “Rate 1”.       |
|  | Changes to the entered “Rate 2”.       |

| Function icon                                                                       | Function                               |
|-------------------------------------------------------------------------------------|----------------------------------------|
|  | Increases the target rate by 10%.      |
|  | Reduces the target rate by 10%.        |
|  | Restores the target rate back to 100%. |

Procedure

To change the target rate during work:





1.  - Activate automatic steering.

2.  - Open main valve.







⇒ Spray cones appear under the boom icon on the work screen. Still, the sprayer is not spraying.

⇒ As long as you are at a standstill, the sprayer cannot start spraying. See icons:  and



3. Exceed the speed defined in the “Regulation off below” parameter.  
⇒ The sprayer begins adjusting the application rate to the defined target rate.
4.  or  - Press to change the target rate.  
⇒ The degree of change appears on the work screen.
5.  - Restores the original target rate.
6. If you have entered several target rates in the configuration, you can also use the function icons:  
 and  to switch among the target rates.

To change the target rate during work:

1.  - Activate automatic steering.
2.  - Open main valve.  
⇒ Spray cones appear under the boom icon on the work screen. Still, the sprayer is not spraying.  
⇒ As long as you are at a standstill, the sprayer cannot start spraying. See icons:  and 
3. Exceed the speed defined in the “Regulation off below” parameter.  
⇒ The sprayer begins adjusting the application rate to the defined target rate.
4.  or  - Press to change the target rate.  
⇒ The degree of change appears on the work screen.
5.  - Restores the original target rate.

### 6.4.3 Setting target rate

The target rate is the quantity of spray liquid you want to apply per hectare.

The job computer will attempt to maintain this rate during the work.

#### Methods

There are several ways to specify the rate:

- **Enter rate on the “Parameters” screen.** [→ 56]
- The target rate can be adopted from external sources using the “ISOBUS-TC” app:
  - from tasks,
  - from prescription maps,
  - from external sensors.

#### Illustration



Target rate from parameters

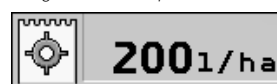



Target rate from an external source

Target rates from external data sources have a higher priority than the target rate entered in the job computer. For this reason, you do not have to adjust the “Rate” parameter when you are working with prescription maps.

As an option, you can enter up to three different target rates in the job computer. To do so, use the “Rate 1” and “Rate 2” parameters in addition to the “Target rate” parameter.

#### 6.4.4 Stopping application





You can stop application in the following ways:

-  - Close main valve.
-  or  - Close the section valves consecutively.
- Drive slower than the set minimum speed (only in automatic mode).

### 6.5 Operating sections

To operate this function the user needs the ME joystick first of all.

Use the following function keys to operate the function:

| Function icon                                                                       | Function                                                                                                                                                                                                                                                                          |
|-------------------------------------------------------------------------------------|-----------------------------------------------------------------------------------------------------------------------------------------------------------------------------------------------------------------------------------------------------------------------------------|
|  | Closes section valves from left to right.                                                                                                                                                                                                                                         |
|  | Closes section valves from right to left.                                                                                                                                                                                                                                         |
|  | Opens section valves from left to right.<br>or<br>When all of the section valves are closed, then the first section valve is opened from the left.                                                                                                                                |
|  | Closes section valves from right to left.<br>or<br>When all of the section valves are closed, then the first section valve is opened from the right.                                                                                                                              |
|  | If the sections were deactivated via SECTION-Control, press and hold for approx. 3 seconds to override the deactivation of the sections. The sections are then opened for approx. 5 seconds. On the work screen, check marks appear at the respective sections for the 5 seconds. |

If your implement has an external main switch, you can use it to open or close all of the sections.

### 6.6 Documenting work results

You can document your work in the “Counters” screen.

On the “Counters” screen, there are two types of counter:











- Trip counter – documents the work until it is deleted.

- Total counter – documents the work since initial start-up.

The “Counters” screen has the following information:

- Quantity - Applied quantity.
- Area - Applied area.
- Distance – Distance driven during the application.
- Work time – Total duration of the application.

Use the following function keys to operate the function:

| Function icon                                                                       | Function                                                                                                                                                                                                                                                                                    |
|-------------------------------------------------------------------------------------|---------------------------------------------------------------------------------------------------------------------------------------------------------------------------------------------------------------------------------------------------------------------------------------------|
|    | Resets the “Volume” counter.                                                                                                                                                                                                                                                                |
|    | Resets the “Area” counter.                                                                                                                                                                                                                                                                  |
|    | Resets the “Distance” counter.                                                                                                                                                                                                                                                              |
|    | Resets the “Work time” counter.                                                                                                                                                                                                                                                             |
|   | Pressed briefly: Continue to the total counters<br>Pressed long: Back to the work screen                                                                                                                                                                                                    |
|  | Clears the contents of the displayed trip counter.                                                                                                                                                                                                                                          |
|  | Stops the trip counter.<br>- The documentation of the work will be stopped until the terminal is restarted or the function button is pressed again.<br><br>- The icon is flashing on the work screen:  |
|  | Next trip counter. (Optional function)                                                                                                                                                                                                                                                      |
|  | Activates the trip counter. (Optional function)                                                                                                                                                                                                                                             |
|  | Previous trip counter. (Optional function)                                                                                                                                                                                                                                                  |

## 6.7 Using pressure registration

The job computer measures the respective current spray pressure every 10 seconds for documentation purposes.

You can view the measured values via the job computer.

Path

This is how you reach the screen with this function:





Procedure

1.  >   - Switch between the individual measurements.

⇒ You can always view the pressures measured in the last hour. The respective pressure is measured every 10 seconds.

## 6.8 Operating the ME joystick



With the ME joystick, you can activate and deactivate the sprayer functions.

For example:

- Open main valve
- Switch off sections from left to right
- Lifting and lowering the boom manually

Side-mounted switch

Three functions are assigned to each button. The position of the side switch determines the function that is executed when a button is pressed.

| Position of the switch                                                              | Color of the LED |
|-------------------------------------------------------------------------------------|------------------|
|    | Red              |
|   | Yellow           |
|  | Green            |

Assignment

The button assignment depends on the configuration of the sprayer.

Procedure

To operate the ME joystick:

- The work screen is called up.
1. Move the side switch into the desired position and hold.
    - ⇒ The LED on the ME joystick lights up in the corresponding colour.
  2. Press button with the desired function.
    - ⇒ The function is executed.

### 6.8.1 Preview mode for the ME Joystick

The preview mode of the joystick can only be used when your joystick works with the AUX1 auxiliary protocol.

When pressing the button for the first time, the preview mode shows the button assignment on the screen. This makes it easier for beginners to activate the right function. As a standard, preview mode is deactivated on new job computers.

Mode of operation

When you press a joystick button for the first time after starting, no function will be executed. The button assignment of the joystick appears on the screen instead. The display remains until the time set in the configuration has expired.

If you press a joystick button during the display, its function will be executed. (Assignment remains on the screen until the time expires).

From now on, you can operate the joystick without the help display appearing.

The help display only appears again if you press a button and simultaneously move the rocker switch on the side to a different position.

#### Procedure

To activate the preview mode:

1. Switch to the "PARAMETERS" screen:

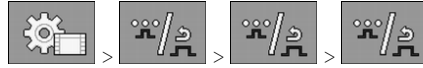

2. For the "ME Joystick" parameter, set the value to "ME Joystick".  
⇒ The "Joystick assistant" parameter appears.
3. Set the check mark for the parameter.
4. If necessary, change the display time.

### 6.8.2

#### Viewing the assignment of the joystick

The assignment of the joystick can only be viewed when your joystick works with the AUX1 auxiliary protocol.

#### Procedure

To display the button assignment on the screen:



- ME Joystick is configured. [→ 59]

1.  - Press until the  button appears.

2.  - Press.

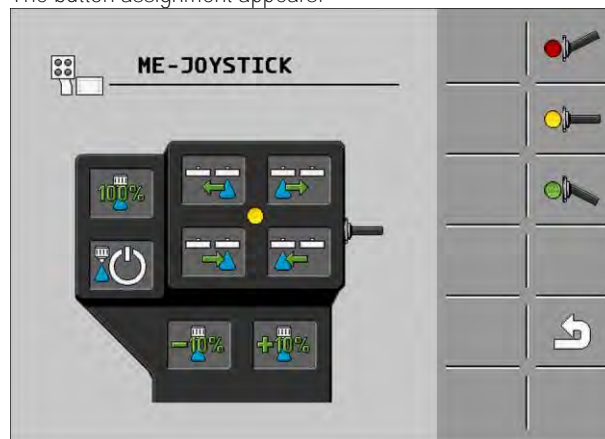
⇒ The button assignment appears:



3.  ,  ,  - Press to view the assignment on each level.
4. You can also activate the Preview mode [→ 49].

### 6.9

#### Using foam markers



Foam markers produce foam that can be applied by the field sprayer driver on the field at the ends of the boom. The driver can then drive parallel to the foam.

#### Path

To access the controls:



Use the following function keys to operate the function:

| Function icon                                                                     | Meaning                                    |
|-----------------------------------------------------------------------------------|--------------------------------------------|
|  | Switches the left foam marker on and off.  |
|  | Switches the right foam marker on and off. |

Illustration

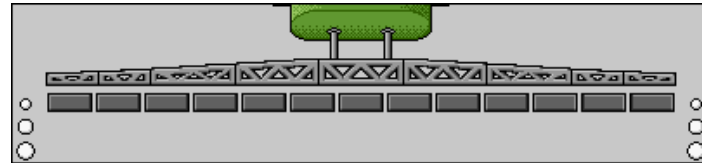

*Foam marker activated on both sides of the boom*

## 6.10

### Operating additional functions

Additional functions are manufacturer-specific functions. They can only be activated or deactivated by pressing a button.









All functions are in the additional screens.

Path

To access the controls:



Additional functions

| Function icon                                                                       | Function that can be activated or deactivated |
|-------------------------------------------------------------------------------------|-----------------------------------------------|
|  | Working light                                 |
|  | Beacon                                        |
|  | Nozzle lighting                               |
|  | Ring line circulation system                  |
|  | Cleaning the ring line circulation system     |
|  | Tank cleaning                                 |
|  | Permanent tank internal cleaning              |
|  | Spray agent pump                              |
|  | Stirrer                                       |

| Function icon                                                                       | Function that can be activated or deactivated         |
|-------------------------------------------------------------------------------------|-------------------------------------------------------|
|    | Low pressure cleaner                                  |
|    | Lift mixing hopper                                    |
|    | Lower mixing hopper                                   |
|    | High pressure cleaner                                 |
|    | Empty fresh water tank                                |
|    | Fill fresh water tank                                 |
|    | Compressed air flushing                               |
|   | Filter rinsing                                        |
|  | Left foam marker                                      |
|  | Right foam marker                                     |
|  | Four hydraulic functions that can be freely connected |
|  | Drop size increase for AIRTEC                         |
|  | Drop size decrease for AIRTEC                         |
|  | Lower the transport hooks for securing the boom.      |
|  | Raise the support leg                                 |
|  | Lower the support leg                                 |

## 6.11

## Regulating the drop size with AIRTEC

AIRTEC is a system for regulating the drop size on field sprayers. It adds compressed air to the spray mixture directly in the nozzle at a ratio calculated by the job computer.

## Requirements

Minimum equipment of the field sprayer:

- Nozzles with air support
- Air compressor: on the field sprayer or on the tractor.

Mode of operation







The job computer regulates the air pressure such that the drop size always remains constant. Even when the spray pressure changes.







Important:



For the system to be able to work optimally at the beginning of the field, the speed should be the same when switching off the sprayer at the end of the field as well as when switching on at the beginning of the field, and should correspond as closely as possible to the normal spraying speed.

Icons

Airtec icons

| Icon                                                                                | Meaning                                                       |
|-------------------------------------------------------------------------------------|---------------------------------------------------------------|
|    | Current air pressure                                          |
|    | System is increasing the air pressure.                        |
|    | System is reducing the air pressure.                          |
|   | Air compressor is off.                                        |
|  | Air compressor is on.                                         |
|  | Manual mode is activated. The number indicates the drop size. |
|  | Drop size (automatic mode activated).                         |

| Function icon                                                                       | Meaning                                                                      |
|-------------------------------------------------------------------------------------|------------------------------------------------------------------------------|
|  | Switches between manual and automatic mode.                                  |
|  | Starts and stops the air compressor mounted on the field sprayer. (optional) |
|  | Larger drops                                                                 |
|  | Smaller drops                                                                |
|  | Increases the pressure.                                                      |
|  | Reduces the pressure.                                                        |

| Function icon                                                                     | Meaning                            |
|-----------------------------------------------------------------------------------|------------------------------------|
|  | Calls up the screen with settings. |
|  | Smaller nozzle.                    |
|  | Bigger nozzle.                     |

## 6.11.1

## Switching the air compressor on and off

The system works with two types of compressors:

- Compressor on the sprayer - is switched on and off on the job computer using a function key.
- Compressor on the tractor

**NOTICE**

Liquid in the compressed air system

Damage to the compressed air system

- Only switch the air compressor off when the AIRTEC nozzles are not installed. If AIRTEC nozzles are installed, the air compressor must be activated.

## Procedure

To switch the air compressor on:



1.  - Press.

⇒ This icon appears on the work screen:



⇒ Air compressor will be switched on.

## Procedure

To switch the air compressor off:



1.  - Press.

⇒ This icon appears on the work screen:



⇒ Air compressor will be switched off.

## 6.11.2

## AIRTEC in automatic mode

In automatic mode, select the drop size that you want to achieve. The air pressure is adjusted so that this drop size is reached.

## Procedure

- AIRTEC nozzles are installed.
- AIRTEC is configured. [→ 77]
- Air compressor is on.



1.   - Setting the drop size.



⇒ The set drop size appears on the work screen:



### 6.11.3 AIRTEC in manual mode

In manual mode, you control the air pressure manually. The air pressure changes the drop size.

Procedure

1.   - Set the air pressure.

⇒ The target air pressure appears beside the icon: 

⇒ As long as the compressor is regulating the air pressure, + or - appears beside this icon:



### 6.12 Using the ISB short-cut button

If you are using your terminal with an ISB short-cut button, you can use it to directly terminate various functions of the implement, depending on the configuration.

The following functions can be configured:

- Sprayer  
All of the spraying functions are stopped.
- TRAIL-Control  
All TRAIL-Control functions are stopped.
- DISTANCE-Control  
All DISTANCE-Control functions are stopped.

## 7 Configuring the job computer

If your system includes additional components, such as TRAIL-Control, DISTANCE-Control, AIRTEC, TANK-Control etc., these must also be configured and calibrated.

### 7.1 Entering sprayer parameters

When to enter?

Enter the parameters in the following cases:

- Prior to initial start-up.
- When the sprayer parameters change.

Procedure

To change the value of a parameter:

1. Switch to the "PARAMETERS" screen:



- ⇒ The "Parameters" screen appears.
- ⇒ A small rectangular box with a value appears under each parameter.

2. Select this box to change a parameter.

- ⇒ Screen for data input or keyboard appears.

3. Enter desired value.

- ⇒ The new value appears on the "Parameters" screen.

The parameters appearing on your screen depend on the type and configuration of your sprayer.

#### 7.1.1 "Nozzle" parameter

Colour of the activated nozzles.

The colours are specified by the ISO standard. The nozzles can also be calibrated. [→ 71]

This parameter only appears on systems that do not have a flow meter. With these systems, a pressure sensor for determining the application rate is used instead.

#### 7.1.2 "Target Rate" parameter

The quantity entered as the target rate will be applied when the sprayer is working in automatic mode.

You can configure up to three different target rates, between which you can switch on the work screen.

#### 7.1.3 "Jump start time" parameter

Set the time during which the sprayer should work with the simulated speed after starting the job computer, before it switches to the regular speed.

This allows you to compensate for any delays occurring in the speed transmission.

#### 7.1.4 "Working Width" parameter

Working width of sprayer.



### 7.1.5 “Wheel Impulses” parameter

Number of impulses the wheel sensor sends to the job computer on a 100m distance. Used to calculate the speed.

The number is determined by the wheel sensor calibration.

### 7.1.6 “Minimum Pressure” parameter

This setting defines the minimum pressure up to which the spraying pressure is optimal.

If the spraying pressure drops below the defined pressure, an alarm is issued.

If no pressure sensor is installed on your sprayer, you must enter “0” as the value.

### 7.1.7 “Maximum Pressure” parameter

This setting defines the maximum pressure up to which the spraying pressure is optimal.

If the spraying pressure increase beyond the defined pressure, an alarm is issued.

If no pressure sensor is installed on your sprayer, you must enter “0” as the value.

### 7.1.8 “Sprayer off Below” parameter

(Minimum working speed)

If the sprayer speed drops below the minimum working speed, the following happens:

- Application will be switched off automatically.

- The work screen displays the icon 

When the value is set to 0, this function is deactivated.

### 7.1.9 “Regulation off Below” parameter

If the sprayer falls below this speed, the following happens:

- The flow will no longer be regulated and the flow remains unchanged.
- Manual mode will be activated.

- The work screen displays the icon 

When the value is set to 0, this function is deactivated.

This parameter must be higher or the same as the “Sprayer off below” parameter.

### 7.1.10 “Regulation Factor” parameter

In Automatic mode, the spray pressure of the nozzles is adapted to the current speed of the sprayer. The adjustment should ensure that the volume of spray liquid that is applied is exactly what you defined in the target rate. The regulation factor plays a decisive role here.

The regulation factor adjusts the reaction speed of the regulation:

- The higher the regulation factor, the faster the spray pressure is adjusted.
- The lower the regulation factor, the more slowly the spray pressure is adjusted.

When setting the regulation factor, you can pay attention to the following:

- If, during movement at constant speed, the current application volume jumps around the target value, you need to reduce the regulation factor.
- If, when speed is changing, the application volume does not adjust to the rate quickly enough, you need to increase the regulation factor.

#### 7.1.11 “Tank Size” parameter

Size of the tank for the spray liquid.

#### 7.1.12 “Tank level alarm” parameter

When the tank content falls below this value, an alarm message appears on the screen.

#### 7.1.13 “Impulses Main Flow” parameter

Number of impulses the flow meter sends to the job computer per one liter of liquid. Used to calculate the application rate.

The number is determined by the flow meter calibration.

#### 7.1.14 “Stirring off Below” parameter

With this parameter, you can set the fill level below which the stirrer should be switched off.

The implement manufacturer (not the user!) can also define whether the stirrer should be switched on automatically when the job computer is started.

#### 7.1.15 “Maximum Wind Speed” parameter

Wind sensor must be installed.

If the maximum wind speed is exceeded, an alarm will be triggered.

#### 7.1.16 “Extremity nozzles set” parameter

With this parameter you can specify which extremity nozzles are mounted on the boom. More about this in section: Extremity nozzles [→ 74]

#### 7.1.17 “Pump” parameter

When the pump speed is higher than the maximum permitted pump speed, an error message appears. This allows drivers to have better control of their work and prevent the pump from being damaged when the speed is too high.

The parameter includes two values:

- Set pump speed.  
Indicates the currently set maximum pump speed.
- “Target”  
Used to change the maximum pump speed.

Procedure To save the current pump speed as the maximum permitted speed:

1. Switch to the “Pump settings” screen:



2. Highlight “Set value” line.
3. Run the pump speed up to the desired value.  
⇒ The current pump speed will be shown on the “Set value” line.



4. - Press.  
⇒ The pump speed from the “Set value” line appears on the top line. In this way it has become the maximum permitted pump speed.

### 7.1.18 “Section Control” parameter

Manner in which the sections are switched on and off.

- **“Sequential mode”** [→ 47]  
This type is intended for normal spraying work. It is also suitable for spraying on wedge-shaped areas and strips that are narrower than the working width of the sprayer.

### 7.1.19 “Filling Mode” parameter

With this parameter, you can define whether you want to use TANK-Control for filling.

- **“Manual”** - For sprayers without TANK-Control.
- **“TANK-Control”** - Activates TANK-Control.

### 7.1.20 “Circulation Type” parameter

- **“Non constant pressure”**  
For manifolds without the “Constant pressure” function.
- **“Constant pressure”**  
For manifolds with the “Constant pressure” function.

## 7.2 Configuring the control units

The joystick and S-Box control units are configured on a screen.

- **“Joystick” parameter:**
  - **“Without Joystick”:** Joystick is not connected. All functions will be controlled using the terminal or an ME S-Box.
  - **“ME Joystick”:** ME Joystick is being used.
  - **“Ignore ME Joystick”:** The joystick should be ignored. Setting for the auxiliary job computer for systems with two job computers.
  - **“ME-Joyst. only On/Off”:** Setting for the auxiliary job computer, if on/off (section main switch) is deactivated on the S-Box.
- **“ME S-Box” parameter:**
  - **“Without ME S-Box”:** No S-Box connected.
  - **“ME S-Box”:** Default setting when the S-Box is available.

- "Ignore ME S-Box": For systems with two job computers, this is the setting for the first job computer. The signals from the ME S-Box are rejected because this job computer should be operated with the joystick.
- "ME SBox without On/Off": Setting for the second job computer.
- "Joystick assistant" parameter:
  - - Preview mode deactivated
  - - Preview mode [→ 49] activated Beside this, you can set the display time for the button assignment.

Procedure

1. Switch to the "PARAMETERS" screen:



⇒ The "AUX controls" screen appears.

2. Configure parameter.

### 7.3

### Calibrating the flow meter

When should you calibrate?

Because the number of impulses per liter can change during the lifespan of a flow meter, calibration must be carried out in the following cases:

- Prior to initial start-up.
- At the start of each season.
- When you detect deviations between the quantity actually sprayed and the quantity displayed.
- When you have replaced or repaired the flow meter.

Methods

There are two ways you can calibrate the flow meter:

- The tank method – it is time-consuming, but precise.
- The nozzle method – it is not as precise as the tank method, but is less time-consuming.

#### NOTICE

##### Imprecise calibration

If the calibration is imprecise, the calculations will be very inaccurate and the application imprecise.

- Calibrate the flow meter very precisely.

#### 7.3.1

#### Calibrating the flow meter with the tank method



Mode of operation

With the tank method, a large quantity of water will be applied from the tank over a specific time.

The flow meter measures the impulses during this time.

After the application, you must enter the quantity of water that has been applied.

The computer calculates the number of impulses per litre.

|                                                                                   |                                                                                                                                                                                                                                                                                                                                                                                  |
|-----------------------------------------------------------------------------------|----------------------------------------------------------------------------------------------------------------------------------------------------------------------------------------------------------------------------------------------------------------------------------------------------------------------------------------------------------------------------------|
|  |  <b>WARNING</b>                                                                                                                                                                                                                                                                                 |
|                                                                                   | <p>Spray liquid or spray liquid residues<br/>Danger of poisoning or chemical burning</p> <ul style="list-style-type: none"> <li>◦ Clean the spray liquid tank thoroughly prior to calibration. The sprayer must be free of spray liquids or spray liquid residues.</li> <li>◦ Use only clear water during calibration.</li> <li>◦ Wear required protective equipment.</li> </ul> |

Procedure

All sections are selected.

Manual mode is activated (the  icon appears in the “Spray data” area of the work screen).

The tank is filled with clear water. For this, you need several hundred litres of clear water.

You have the option of weighing the entire trailer or measuring the volume of water applied with another method.

Pump is switched on.

1. Ensure that all prerequisites have been fulfilled.

2. Weigh the tank.

3. Switch to the “CALIBRATION” screen:





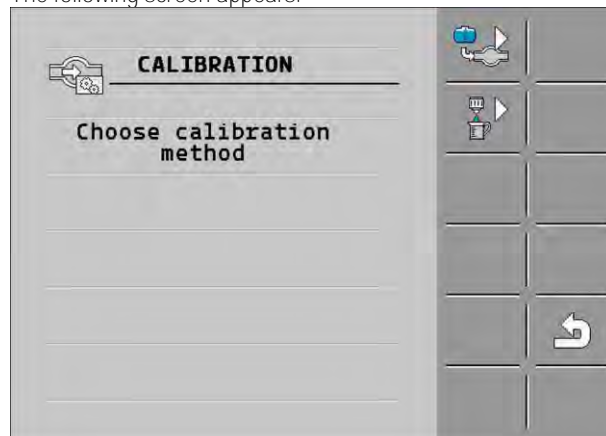

⇒ The following screen appears:

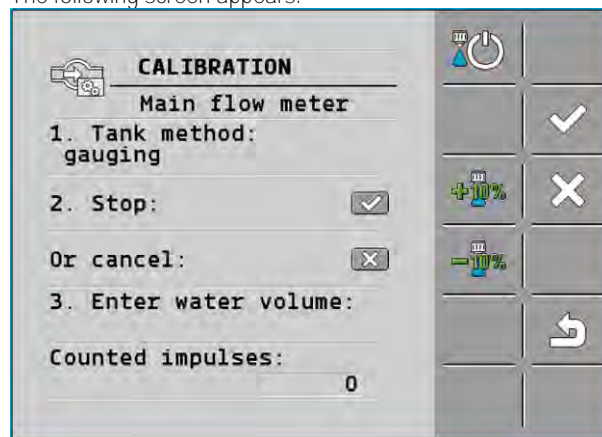

4.  - Select the tank method.

⇒ The following screen appears:



5.  - Start application  
 ⇒ During application, the number of impulses will be counted on the “CALIBRATION – Main flow meter” screen.
6. Apply a few hundred litres. Do not fully empty the tank. This prevents air bubbles from forming and distorting the results.
7.  - Stop the application.  
 ⇒ The application will be stopped.  
 ⇒ No impulses are counted on the display.
8.  - Stop calibration.
9. Weigh the tank.
10. Enter the applied quantity in litres on the “Enter water volume” line.
11.  - Exit the screen.  
 ⇒ You have calibrated the flow meter with the tank method.

### 7.3.2 Calibrating the flow meter with the nozzle method

When calibrating the flow meter using the nozzle method, you determine the average quantity of the liquid applied through a nozzle in a specific time.



#### Mode of operation

When calibrating using this method, you must apply clean water over the entire working width and measure the applied quantity on different nozzles using a measuring cup.

The flow meter measures the impulses during this time.

When you have finished the application, you must enter how much water was applied on average by one nozzle in one minute.

The computer calculates the number of impulses per litre.

|                                                                                   |                                                                                                                                                                                                                                                                                                                                                                                  |
|-----------------------------------------------------------------------------------|----------------------------------------------------------------------------------------------------------------------------------------------------------------------------------------------------------------------------------------------------------------------------------------------------------------------------------------------------------------------------------|
|  |  <b>WARNING</b>                                                                                                                                                                                                                                                                                 |
|                                                                                   | <p>Spray liquid or spray liquid residues<br/>Danger of poisoning or chemical burning</p> <ul style="list-style-type: none"> <li>◦ Clean the spray liquid tank thoroughly prior to calibration. The sprayer must be free of spray liquids or spray liquid residues.</li> <li>◦ Use only clear water during calibration.</li> <li>◦ Wear required protective equipment.</li> </ul> |

Procedure



- Manual mode is activated (the  icon appears in the “Spray data” area of the work screen).
- You have prepared a measuring cup to measure the applied quantity.
- You have prepared a stopwatch to be able to count one minute precisely.
- All of the sections are preselected, and the sprayer can apply over the entire working width.
- The tank is filled with clear water.
- The set working width is correct.
- The number of nozzles per section and the number of sections is entered correctly.

1. Ensure that all prerequisites have been fulfilled.
2. Switch to the “CALIBRATION” screen:

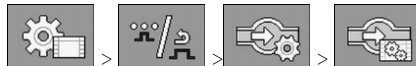

⇒ The following screen appears:

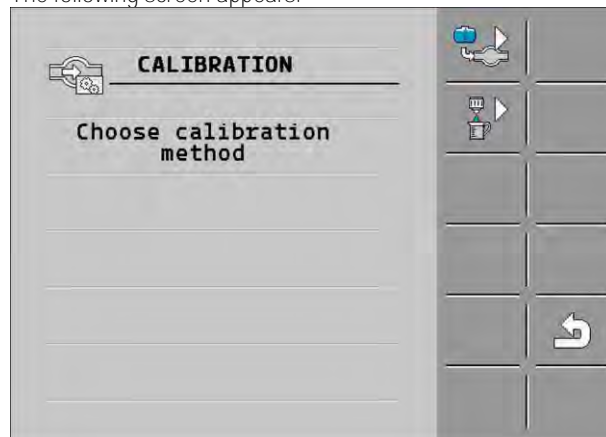



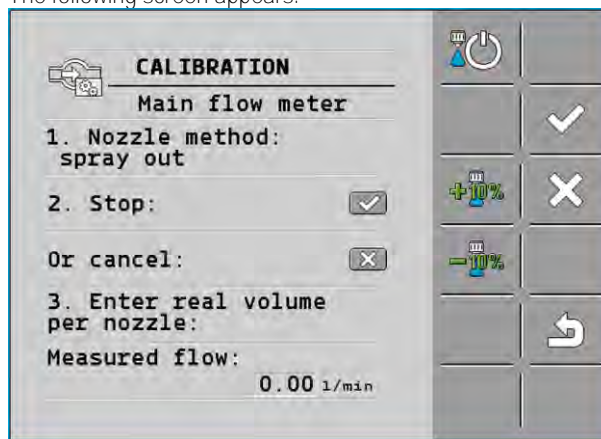

3.  - Select the nozzle method.

⇒ The following screen appears:



⇒ The current flow appears on the “Measured flow” line.

4.  - Start application
  5. Go to one of the nozzles and carefully collect the water sprayed for 60 seconds by using the prepared measuring cup.
  6. Write down the applied water volume.
  7. Repeat the last two steps on several nozzles.
  8. Calculate and write down an average of several measurements.
  9.  - Stop application.  
⇒ The application will be stopped.
  10.  - Stop calibration.  
⇒ On the „3. Enter real volume per nozzle ” line, an input box appears.
  11. Enter the average applied volume in litres in this box.
  12.  - Exit the screen.  
⇒ The value of the “Impulses main flow” parameter will be updated.
- ⇒ You have calibrated the flow meter with the nozzle method.

### 7.3.3 Manually entering the number of impulses per liter for the flow meter

If you know the precise number of impulses per liter for the flow meter, you can enter this value manually.

Procedure

1. Switch to the “FLOW METER” screen:



2. Enter number of impulses per litre on the “Impulses main flow” line.

### 7.3.4 Combining the flow meter with the pressure sensor

If a pressure sensor is installed on the sprayer, you can combine the regulation via the flow meter and the pressure sensor. This enables more stable regulation even at low flow rates.



Procedure

1. Switch to the "FLOW METER" screen:

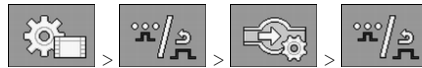

2. Activate the "Combined flow/pressure regulation" parameter.
3. Configure parameter.

**"Flow Tolerance" parameter**

Enter a percent value at which the system should switch to pressure regulation. If the difference between the calculated flow from the pressure sensor and the measured flow from the flow meter is greater than the entered value, the system switches to pressure control.

**"Threshold Flow" parameter**

Enter the minimum flow that must be reached for flow regulation to be used. If the flow rate is below the entered value, the system switches to pressure control.

7.4

Calibrating an analogue pressure sensor

If an analogue pressure sensor is installed on the sprayer, you have to calibrate it before initial use. Calibration determines how high the respective current is when there is no pressure and at maximum pressure.

Procedure

- You have a reference sensor at hand to measure the pressure.

1. Switch to the "PRESSURE MEASUREMENT" screen.



- ⇒ The "PRESSURE MEASUREMENT" screen appears.
- ⇒ The currently measured pressure appears.

2.  - Open the "CALIBRATION" screen.

3. Use the reference sensor to verify the pressure of 0 bar.

4.  - Open the calibration for the zero value.

5. Switch off the implement to put it in a depressurized state.

6.  - Start the calibration for the zero value.  
⇒ The current is being measured.

7. Using the pressure regulator, set the maximum system pressure and measure it with an external reference pressure sensor.

8. Enter the maximum pressure of the flow meter in the "Maximum pressure" parameter.

9.  - Open the calibration for the maximum value.

10.  - Start the calibration for the maximum value.  
⇒ The current is being measured.

11. You have completed the calibration of the analogue pressure sensor.

## 7.5 Selecting and configuring the speed sensor

You must enter the source from which the job computer shall obtain the current speed.

The configuration procedure can differ depending on the speed source.

### 7.5.1 Selecting the speed source

Supported speed sources:

- “Sensor” – Sensors that are installed on the implement and connected to the job computer:
  - Examples: Wheel sensor, radar sensor, impulse-transmitting GPS speed sensor
  - Configuration: Configure the number of impulses per 100 meters.
- “ISOBUS” – Sensors that are installed on the tractor and whose signal is received through the ISOBUS.
  - Examples: GPS receiver, wheel sensor on the tractor, signal socket
  - Configuration: For systems without the option of selecting the sensor input, the “Wheel impulses” parameter must be set to 0.
- “Auto” – Some systems enable automatic detection of the speed source.
  - Mode of operation: If a speed signal is detected on the ISOBUS, this speed will be used as a basis. In the case of signal failure, the job computer will take the impulses from the sensor connected to the job computer as a basis for determining the speed.
  - Configuration: For systems that have two sensor types, it is recommended to calibrate the sensor that is connected to the job computer. In other cases, set the “Wheel Impulses” parameter to 0.

#### Procedure 1

To configure the speed source:

1. On the work screen, press the following keys successively:



⇒ The “Speed” screen appears.

2. Configure the “Speed source” parameter.

#### Procedure 2

If the “Speed source” parameter does not appear on the “Speed” screen, and the speed signal should be received through the ISOBUS, proceed as follows:

- The speed signal can be received through the ISOBUS.

1. Switch to the “PARAMETERS” screen:



2. Set the “Wheel impulses” parameter to “0”.

### 7.5.2 Calibrating the speed sensor with the 100m method

When calibrating the speed sensor with the 100m method, you determine the number of impulses received by the speed sensor in a distance of 100m. When you know the amount of impulses, the job computer can calculate the current speed.

If you know the number of impulses for the wheel sensor, you can also enter this number manually.

You can enter different pulse values for up to three different wheels.

Procedure

- ☑ Wheel sensor, radar sensor or GPS speed sensor is installed on the implement.
- ☑ A distance of 100m has been measured and marked. The distance must correspond to the field conditions. It should therefore lead over a meadow or a field.
- ☑ The tractor with connected implement is ready for a 100m drive and is at the start of the marked distance.

1. Ensure that all prerequisites have been fulfilled.
2. Switch to the “CALIBRATION – wheel impulses” screen:



3.  - Start calibration.

⇒ The following function icons appear:

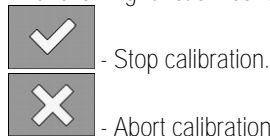

4. Drive the previously measured 100m distance and stop at the end.  
⇒ During the drive, the currently determined impulses are displayed.

5.  - Stop calibration.

6.  - Exit the screen.

⇒ The number of impulses appears on the “Wheel impulses” line

7.5.3

Configuring the reverse driving sensor

If the trailed implement or the tractor sends a reverse driving signal through the ISOBUS, the job computer can use this signal to adjust its regulating behaviour when driving in reverse.

You can find more information in this section: Configuring automatism when driving in reverse

Signal sources

The following signal sources are possible:

- “None” - The job computer should not expect a reverse driving signal. Even if a reverse driving signal is transmitted through the ISOBUS, the job computer will ignore the signal.
- “ISOBUS” - The reverse driving signal is sent by the tractor or a different job computer through the ISOBUS.
- “Sensor” - A reverse driving sensor is connected to the junction box or cable harness of the job computer.

Procedure

To select the reverse signal source:

1. Switch to the “SPEED” screen:



2. Select the box below the “Reverse drive sensor” parameter.  
⇒ The available signal sources appear. See the description at the beginning of this section.
3. Select the signal source.
4. Restart the job computer.

## 7.5.4 “Simulated Speed” function

The simulated speed function is only used during tests and when looking for faults. It simulates the movement of the implement when the implement is at a standstill.

By activating the “Simulated speed” function, it is possible for customer service employees to check the correct functioning of a sensor.

By default, the value is set at 0 km/h and the function is switched off.

After restarting the computer, the function is always deactivated.

The most recently set value is saved and used for the next activation.

### Procedure

1. Switch to the “Speed” screen:



2.  - Activate the simulated speed. By pressing again, you can deactivate the function.  
⇒ The “Simulated speed” line appears.

3. Enter the speed to be simulated on the “Simulated speed” line.

4.  - Exit the screen.

⇒ The set speed and the flashing  icon appear on the work screen.

## 7.6 Configuring sections

### 7.6.1 Entering the number of nozzles per section

You must enter the number of nozzles installed on each section.

#### When to enter?

- Prior to initial start-up.
- If the number of nozzles in a section changes.

#### Procedure

1. Switch to the “Boom” screen:



⇒ The “Boom” screen appears.

⇒ Here, you can see the set working width, the number of sections and the number of nozzles. The two last values may not be changed.

2.  - Press.  
⇒ The “NUMB. OF NOZZLES” screen appears.

3. Here, you can enter the number of nozzles for each section. Multiple nozzle holders count as one nozzle in this case.

⇒ With each change, the number of nozzles changes on the “BOOM” screen.

### 7.6.2 Switching sections off permanently

You can permanently switch off any section. This is useful, for example, if the tramlines on the field are designed for a smaller field sprayer than yours.

## Results

Switching off the outer sections has the following effects:

- With TRACK-Leader: The newly calculated working width will not be taken into account for the calculation of the headland width.
- With SECTION-Control: After switching off the outer sections, you will need to change the “Line spacing” parameter so that the distance between the guidance lines matches the actual working width. You cannot change the “Working width” parameter.
- The actual working width changes. However, as the sprayer has not changed:
  - Do not change the “Working width” parameter.
  - Do not change the sprayer geometry.

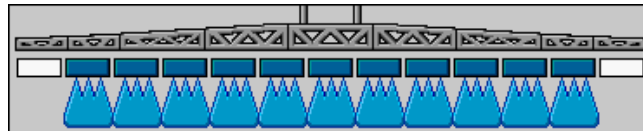

Permanently switched off sections are marked in white on the work screen

## Procedure

1. Switch to the “Boom” screen:



⇒ The “Boom” screen appears.

2. - Press.

⇒ The “Sections” screen appears.

⇒ For each section, you can see one of the following icons:



- Section activated



- Section deactivated.

3. For each section, you can select and change this icon.

### 7.6.3

#### Permanently switching off a section using a sensor

If a sensor for monitoring the unfolding of boom sections is installed on the boom, sections can be automatically permanently switched off.

This enables the use of a field sprayer with multiple working widths without having to change the configuration each time.

### 7.6.4

#### System delay when switching the sections

For SECTION-Control to be able to open and close the section valves precisely, you must determine how many milliseconds are required for the liquid to travel from the valve to the nozzle. Afterwards, the job computer will switch the valves earlier or later accordingly.

## Procedure

- You are using the automatic SECTION-Control.

1. Read the operating instructions for the TRACK-Leader app to find out how to determine the delay times.
2. Determine the delay times.
3. Open the job computer application.

4. On the work screen, press:

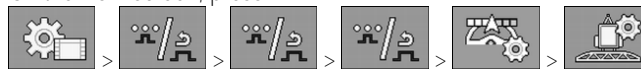

⇒ The “SECTION-Control” screen appears:

5. Enter the determined delay times under “Delay on start” and “Delay on stop”.

### “Delay on Start” parameter

Time that elapses between the opening of a section valve and the emergence of liquid out of the nozzles.

Rule of thumb:

- If the sprayer switches too late, increase the value of the parameter.
- If the sprayer switches too early, decrease the value of the parameter.

### “Delay on Stop” parameter

Time during which the nozzles continue spraying after the valve has been closed.

Rule of thumb:

- If the sprayer switches too late, increase the value of the parameter.
- If the sprayer switches too early, decrease the value of the parameter.

## 7.6.5

### Changing the display of areas on the terminal

You can make different settings to change the display of the areas on the terminal, e.g. for the TRACK-Leader application.

#### Procedure

1. On the work screen, press:



2. Configure the “Zero target rate areas” parameter. The following configuration options are available to you:

| Sections off | Applied on the map | Function                                                                                                                                                                                                 |
|--------------|--------------------|----------------------------------------------------------------------------------------------------------------------------------------------------------------------------------------------------------|
| deactivated  | ---                | The sections are not closed when the application rate is 0 l/ha.<br>Everything is recorded in the process.                                                                                               |
| activated    | deactivated        | The sections are closed when the application rate is 0 l/ha.<br>Only the applied areas are recorded.                                                                                                     |
| activated    | activated          | The sections are closed when the application rate is 0 l/ha.<br>Both the applied areas and areas where nothing was applied will be recorded.<br>This is the standard setting when using SECTION-Control. |

## 7.7 Configuring the nozzles - for sprayers with pressure sensor regulation

By configuring the nozzle type, the job computer can calculate the current application rate based on the measured spray pressure.

You only have to configure the nozzles if a pressure sensor is installed on the sprayer.

If no pressure sensor is installed on the sprayer and the application rate is regulated only through the flow rate, then you do not need to configure the nozzles.

### 7.7.1 Nozzle assistant

The nozzle assistant serves the following purposes:

- To show how the nozzle type affects the possible application rates and speeds.
- To help with the correct selection of the installed nozzle type.
- To change the target rate.

| Function icon                                                                     | Meaning                     |
|-----------------------------------------------------------------------------------|-----------------------------|
|  | Changes the calculated data |

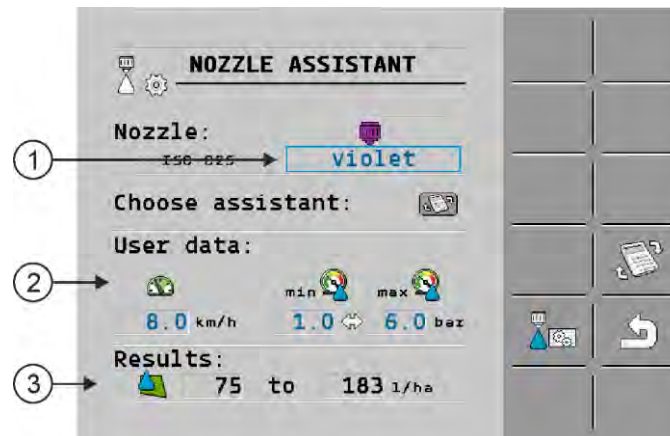

*Determination of possible application rates*

|   |                                                                                                   |
|---|---------------------------------------------------------------------------------------------------|
| ① | Selected nozzle                                                                                   |
| ② | Here, you can enter:<br>- The intended working speed<br>- The optimal pressure for the nozzle     |
| ③ | Here, you can see which application rates are possible with this nozzle at the set working speed. |

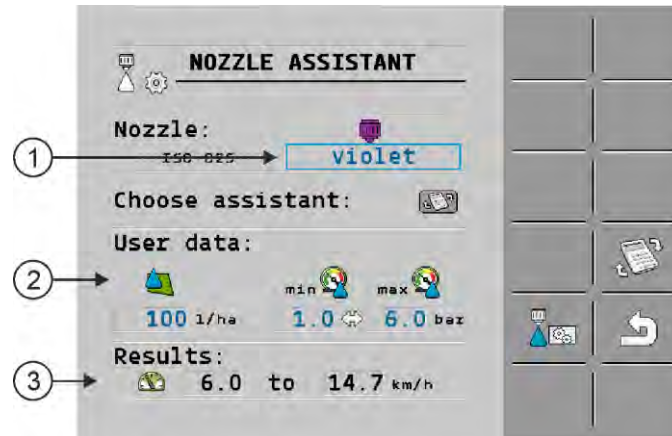

Determination of the fitting nozzles

|   |                                                                                                                                                      |
|---|------------------------------------------------------------------------------------------------------------------------------------------------------|
| ① | Selected nozzle                                                                                                                                      |
| ② | Here, you can enter:<br>- The intended application rate This is adopted directly from the "Rate" parameter.<br>- The optimal pressure for the nozzle |
| ③ | Here, you can see the speed at which this application rate can be reached.                                                                           |

Procedure

To calculate the application rate that can be reached with a nozzle at a given pressure:

1. Switch to the "Nozzle assistant" screen:



2.  - Press for the  speed icon to appear in the "User data" area.

3. Select the box with the nozzle colour to select a nozzle.  
⇒ The list contains all standard nozzles and four positions for the configuration of custom nozzles.

4. Enter the intended working speed in the  box.



5. In the  area, set the optimal pressure range that enables the intended drop size with the selected nozzle. This value can be found on the nozzle data sheet.  
⇒ Note: The pressure range set here will not be adopted for the application. During operation, you must ensure for yourself that the sprayer is working in the intended pressure range.  
⇒ In the "Results" area, the possible application rates appear.

If the calculated application rate is too high or too low:

- Change the working speed.
- Install different nozzles. Perform the calculation for the new nozzle colour.

Procedure

The calculation can be performed based on the intended application rate:

1.  - Press for the  icon to appear in the "User data" area.

2. Enter the intended application rate in the  field.

3. Enter the pressure range for the nozzle colour.



4. In the “Results” area, you can see the speed at which the application rate can be achieved.

7.7.2

Calibrate the nozzles

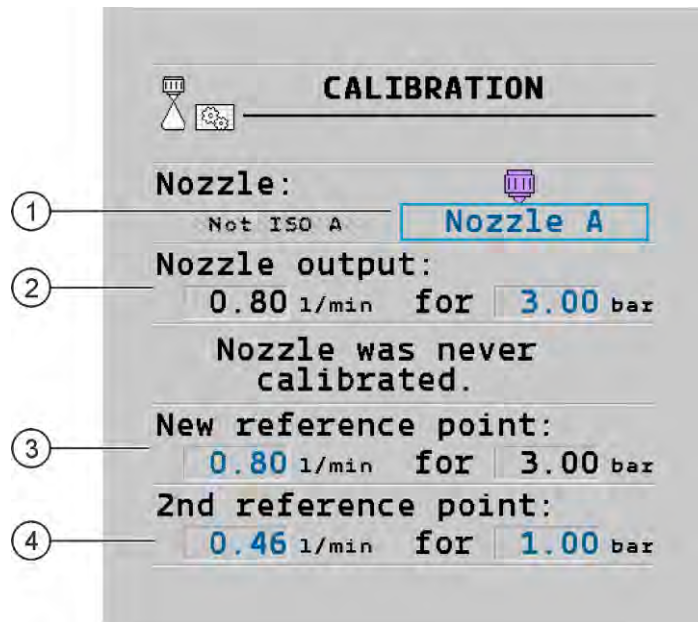

“Calibration” screen

|   |                                                                                                  |   |                                                                                                                                                             |
|---|--------------------------------------------------------------------------------------------------|---|-------------------------------------------------------------------------------------------------------------------------------------------------------------|
| ① | Selected nozzle                                                                                  | ③ | Nozzle output at 3 bar - Result of the calibration                                                                                                          |
| ② | Current nozzle output. When you change the pressure, the newly calculated nozzle output appears. | ④ | For non-standard nozzles, the calibration must be repeated at a different pressure. This pressure should be about as high as the intended working pressure. |

|  |                                                                                                                                                                                                                                                                                                                                                                                  |
|--|----------------------------------------------------------------------------------------------------------------------------------------------------------------------------------------------------------------------------------------------------------------------------------------------------------------------------------------------------------------------------------|
|  | <b>WARNING</b>                                                                                                                                                                                                                                                                                                                                                                   |
|  | <p>Spray liquid or spray liquid residues<br/>Danger of poisoning or chemical burning</p> <ul style="list-style-type: none"> <li>◦ Clean the spray liquid tank thoroughly prior to calibration. The sprayer must be free of spray liquids or spray liquid residues.</li> <li>◦ Use only clear water during calibration.</li> <li>◦ Wear required protective equipment.</li> </ul> |

Procedure

Calibrate a standard nozzle as follows:

- The tank is filled with clear water.
  - There are no spray liquid residues in the tank or the pipelines.
1. - On the work screen, switch the application mode to manual.
  2. - Start application
  3. and - Set the spray pressure to 3 bar.
  4. Using a measuring cup, collect the water from several nozzles for one minute each.

5. Calculate average application rate.



6. - Stop the application.



7. - Activate automatic mode.

8. Switch to the “Calibration” screen:



9. On the “Nozzle” line – select nozzle for calibration. Standard nozzles are referred to by their colours.

10. In the box below the “New reference point” line, enter the calculated average quantity in l/min.

11. For undefined nozzles, you must also enter the nozzle's minimum output in the “2nd reference point” parameter. To do so, you must repeat the procedure at a different pressure.

⇒ You have calibrated the selected nozzle.

## 7.8

### Extremity nozzles

Extremity nozzles are nozzles with a different spray pattern from the other nozzles on the boom. They can either restrict the spray width, in which case they are used for spraying field edges (corner nozzles), or increase the spray width of a section (wide area nozzles).

Before using extremity nozzles, note the following:

- Wide area nozzles or corner nozzles can be installed as extremity nozzles. You can choose the icon used to represent the extremity nozzle on the work screen.
- Extremity nozzles can be installed at the outer end of any section.
- The width of the spray cone is irrelevant for the ISOBUS job computer. It is never detected and is not taken into account in the following calculations:
  - when calculating the working width,
  - when calculating the applied quantity,
  - when calculating the tank content.
- The TRACK-Leader and SECTION-Control applications from Müller-Elektronik do not take account of the width of the spray cone from the extremity nozzles; they treat them as normal nozzles. If you are using these applications, you may have to adjust the working width manually.

7.8.1 Configuring the extremity nozzles

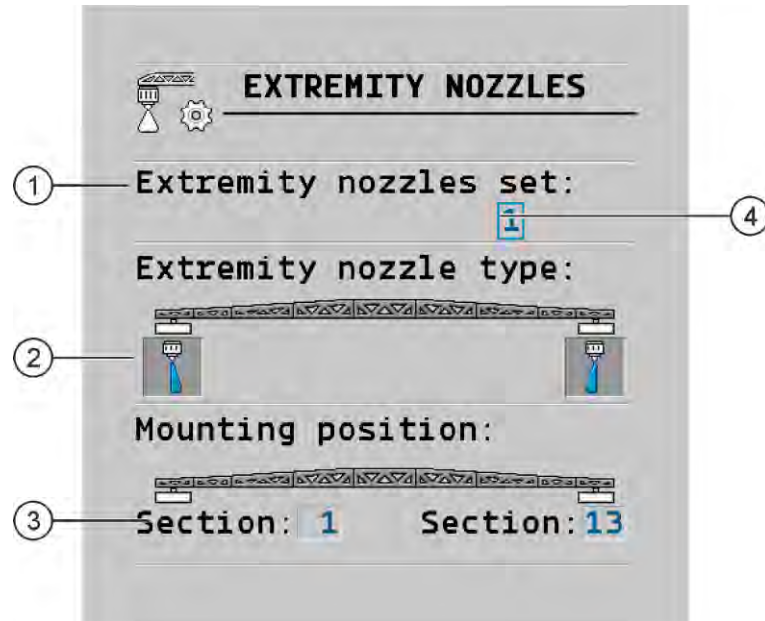

Screen for configuring the extremity nozzles

|   |                                                           |   |                                          |
|---|-----------------------------------------------------------|---|------------------------------------------|
| ① | “Extremity nozzles set” parameter                         | ④ | Currently selected extremity nozzle pair |
| ② | Extremity nozzles left and right                          |   |                                          |
| ③ | Installation site for the left and right extremity nozzle |   |                                          |

“Extremity nozzles set” parameter

You can define up to three sets of extremity nozzles via the “Extremity nozzles set” parameter. For each set, you can define the installation site and the relevant work screen icon.

Meaning of the icons

| Icon | Meaning          |
|------|------------------|
|      | No nozzle        |
|      | Corner nozzle    |
|      | Wide area nozzle |

Procedure

To configure the extrem. nozzles modes:

1. Call up the screen with the extremity nozzle settings:



⇒ The following screen appears:

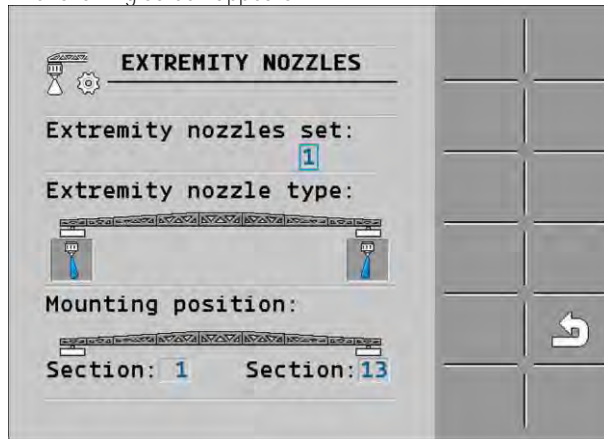

2. On the “Extremity nozzles set” line, enter the set of extremity nozzles for which you want to enter settings. For example “2”:
  - ⇒ The saved settings appear on the screen.
3. Select one of the nozzle icons under the boom icon.
4. Select the type of extremity nozzle required.
  - ⇒ An alarm message appears. This message informs you that the job computer must be restarted so that the changes can be applied. Do not restart the job computer yet; wait until you have entered all the settings.
5. In the “Installation site” area, enter the section on which the extremity nozzles are installed.
6. Restart the job computer.

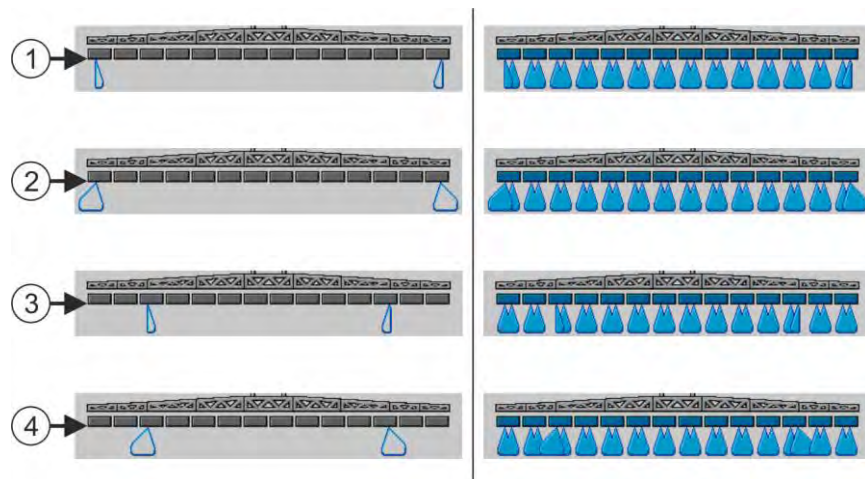

### 7.8.2

#### Operating the extremity nozzles



Extremity nozzles on the work screen: Left: before application; Right: during application.

|   |                                        |
|---|----------------------------------------|
| ① | Corner nozzles on sections 1 and 14    |
| ② | Wide area nozzles on sections 1 and 14 |
| ③ | Corner nozzles on sections 3 and 12    |
| ④ | Wide area nozzles on sections 3 and 12 |

| Function icon                                                                     | Meaning                                                     |
|-----------------------------------------------------------------------------------|-------------------------------------------------------------|
|  | Activate and deactivate corner nozzles on left and right    |
|  | Activate and deactivate wide area nozzles on left and right |

#### Procedure

To operate the extremity nozzles:

1. Stop application.
2. Change to the additional screens:



⇒ Function icons used to operate the extremity nozzles should appear on the screen.

3. Press the function keys for the extremity nozzles to show them on the screen.

⇒ Spray cones for the extremity nozzles appear below the boom icon. The icons are only used to show the extremity nozzle positions.

## 7.9

### Configuring AIRTEC

For the AIRTEC configuration, you only have to select the nozzle number for the mounted nozzle.

#### NOTICE

Wrong nozzle number  
Damage to the plants

- Always enter the correct nozzle number.

#### Procedure

1. Switch to the "AIRTEC" screen:



2.  - Set the nozzle number.

## 7.10

### Entering the sprayer geometry

Sprayer geometry is a set of parameters that describe the dimensions of your implement.

Setting the sprayer geometry lets the software know exactly how long and how wide the sprayer is and where the individual sections are located.

#### Sprayer geometry parameters

When setting the sprayer geometry, you must measure the following distances:

- CRP – Attachment point, or point from which the measurements are taken. For self-propelled sprayers, it can be the position of the GPS receiver, and for mounted and trailed sprayers, the mounting or attachment point.
- DRP – Pivot point of the sprayer, or point at which there is soil contact.
- ERP – Position of the nozzles.

Procedure

1. Switch to the “Geometry” screen:

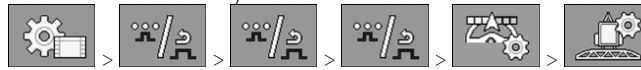

⇒ The following screen appears:

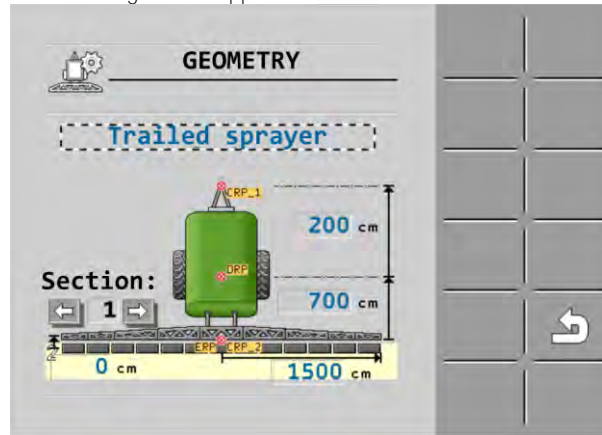

2. Select the sprayer type in the topmost box.  
⇒ A diagram of the sprayer appears.
3. Measure the distances shown in the figure.
4. Enter the distances measured.

## 7.11

### Configuring the Raven direct injection

If your sprayer is equipped with a direct injection manufactured by Raven, you have to configure it before using it for the first time.

Procedure

1. Switch to the “INJECTION” screen:



2. Activate the units that you want to use.



3. - Switch to the calibration and diagnostics screen.





4. Assign the individual units to each “ECU number”.

⇒ You have configured the Raven direct injection.

⇒ Depending on the status, the following icons can appear:

#### Status of the Raven direct injection

| Display on the calibration screen | Display on the work screen | Meaning                                                                                                                                    |
|-----------------------------------|----------------------------|--------------------------------------------------------------------------------------------------------------------------------------------|
|                                   |                            | The job computer did not recognise the injection unit on the ISOBUS.                                                                       |
|                                   |                            | The job computer recognised the injection unit on the ISOBUS, but is not receiving any messages from this unit.                            |
|                                   |                            | The job computer recognised the injection unit on the ISOBUS, and is also receiving messages from this unit. There is a connection between |

| Display on the calibration screen                                                 | Display on the work screen                                                        | Meaning                                                                                                                                                                                                                                        |
|-----------------------------------------------------------------------------------|-----------------------------------------------------------------------------------|------------------------------------------------------------------------------------------------------------------------------------------------------------------------------------------------------------------------------------------------|
|                                                                                   |                                                                                   | the job computer and the injection unit. But the injection unit is currently not ready.                                                                                                                                                        |
|  |  | The job computer recognised the injection unit on the ISOBUS, and is also receiving messages from this unit. There is a connection between the job computer and the injection unit. The injection unit is ready, but the pump is switched off. |
|  |  | The job computer recognised the injection unit on the ISOBUS, and is also receiving messages from this unit. There is a connection between the job computer and the injection unit. The injection unit is ready and the pump is switched on.   |

## 7.12

### Calibrating the sensors for reproducing the boom slope

The purpose of the calibration process is to detect and save the boom position at maximum slope and in the horizontal position.

You must perform the calibration in the following instances:

- Prior to initial start-up.
- When the boom slope is not displayed correctly.

#### Illustration

The current boom position can appear at the following places:

- Work screen
- “BOOM SLOPE CONTROL” screen

The explanation for the display can be found in section: Reproducing the boom slope when turning [→ 40]

#### Procedure

To calibrate the angle sensor:

1. Position the field sprayer on level ground.
2. Switch to the “Boom slope control” screen:



⇒ The “Boom Slope Control” screen appears.

3.  - Press.

4. Position the boom horizontally. The actual boom position is important here. The display on the screen is not calibrated yet at this time.

5.  - Initiate calibration of the horizontal position.

⇒ The following progress icon appears: 

⇒ You must now start the calibration within a few seconds.

6.  - Start calibration.



- ⇒ Horizontal position is being saved as long as the  icon appears.
- ⇒ You have saved the horizontal position.

7. Slope the boom to the right.



8.  - Calibrate the slope to the right. Proceed in the same way as for the horizontal position.

9. Slope the boom to the left.



10.  - Calibrate the slope to the left.

## 7.13

### Field sprayer with two circulations and job computers

For field sprayers with two manifolds and booms, which are controlled by two job computers, you must configure each job computer for the equipment of the respective boom.

There are also the following settings:

- You must decide which system should be the main system and which should be the auxiliary system. On the main job computer, mark the 2nd [→ 81] connector parameter.
- You must set the geometry on both job computers. [→ 82]
- You have to select an operating device for each boom. [→ 59]

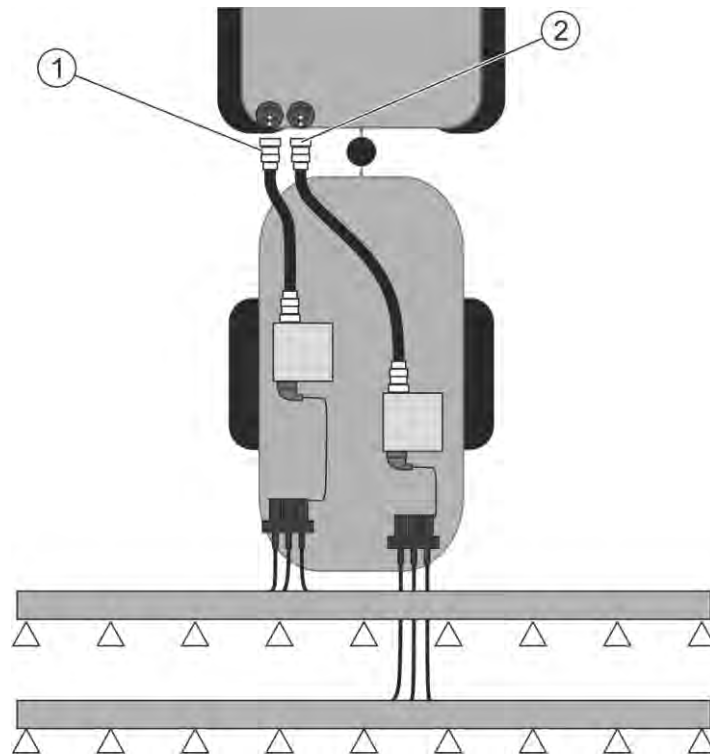

Field sprayer with two booms at the rear.

|   |             |   |                  |
|---|-------------|---|------------------|
| ① | Main system | ② | Auxiliary system |
|---|-------------|---|------------------|



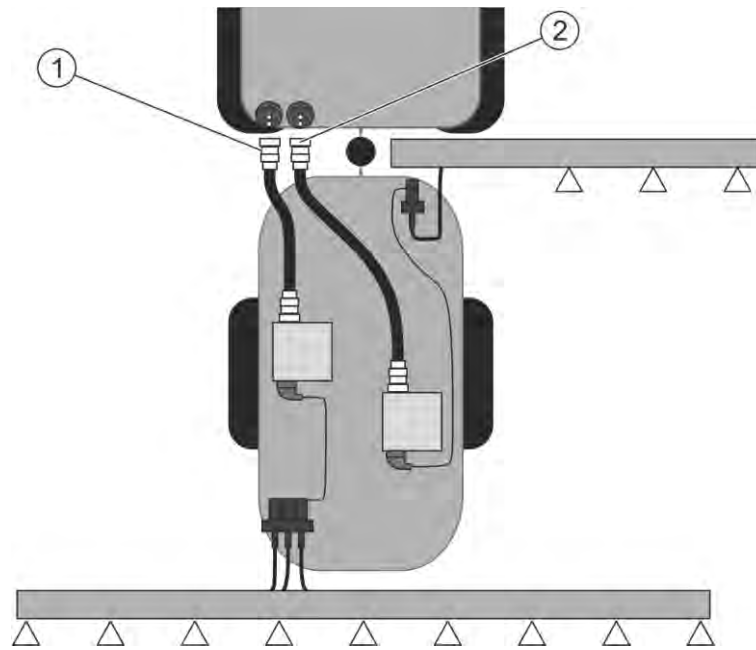

Field sprayer with one boom at the front and one at the rear.

|   |             |   |                  |
|---|-------------|---|------------------|
| ① | Main system | ② | Auxiliary system |
|---|-------------|---|------------------|

### 7.13.1

#### Identifying the job computer

For systems with two ISOBUS job computers, you must identify both job computers. You must activate the so-called second connector on the main job computer.

The second connector is a virtual connection for a second ISOBUS job computer. By activating the parameter, you are telling the ISOBUS system that there is a second implement in addition to the implement that is controlled by the main job computer.

The terminal can then take account of the geometry of both implements and thus enable section control. In doing so, the position of the second implement is always indicated relative to the position of the first implement.

A second manifold with boom can be considered as the second implement - like the example in these instructions. However, a different implement can also be mounted behind the field sprayer or in front of the tractor.

Because the system described here does not have a second ISOBUS power socket, you must use a second ISOBUS power socket on the tractor.

| Parameter        | Standard system without auxiliary job computer | With two manifolds: Main job computer | Auxiliary job computer |
|------------------|------------------------------------------------|---------------------------------------|------------------------|
| No. 'ECU Number' | 1                                              | 1                                     | 2-32                   |
| 2nd connector    | Do not activate                                | activate                              | Do not activate        |

#### Procedure

- You have entered the user and service password.

1. Switch to the "ISO 11783" screen:



⇒ The “ISO 11783” screen appears:

2. Configure parameter.

### 7.13.2

### Geometry on a field sprayer with two job computers

You must measure and enter the following distances:

- On the main job computer: Distances between the main boom, the axle, and the attachment point.
- On the auxiliary job computer: Distance between the main boom (CRP\_2) and the auxiliary boom.

On systems with a one-sided folding auxiliary boom [→ 81], you must also enter the distance DRP\_Y:

- The boom is located only on the left side: 0cm
- Boom on the right side: Working width of the boom in cm

#### Procedure

To enter the sprayer geometry in the main job computer:

- You have set the second connector on the main job computer.

1. Switch to the “Geometry” screen in the application of the main job computer:



⇒ The following screen appears:

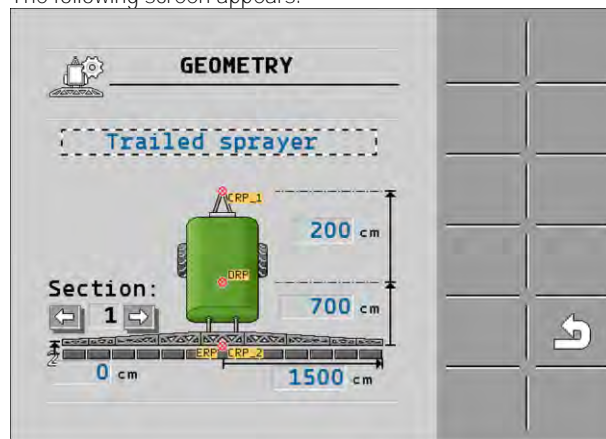

⇒ There are two red dots on the diagram: CRP\_1 - Attachment point; DRP - Axle; CRP\_2 - Work point of the main boom. You must also measure the distance from this point to the second boom later.

2. On the line above the drawing, set the corresponding sprayer type.
3. Enter the measured values.

#### Procedure

To enter the sprayer geometry in the auxiliary job computer:

1. Switch to the “GEOMETRY” screen in the application of the auxiliary job computer:



⇒ The following screen appears:

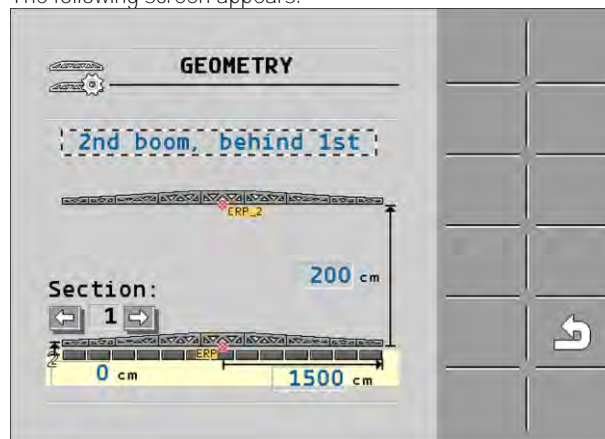

⇒ The red dot CRP\_2 marks the first boom.

2. On the line above the drawing, select whether the second boom is located in front of or behind the first boom (looking in the direction of travel): “2nd boom, behind the 1st” or “2nd boom, front of 1st”
3. Measure the distance between CRP\_2 and the second boom (ERP) and enter this value.

## 7.14

### Activating licenses

If you want to extend the functions of your job computer, you can activate additional licenses. You need a password for this.

#### Procedure

1. Switch to the “Licenses” screen:



⇒ The “Licenses” screen appears.

2. In the “App” parameter, select the application that you want to activate.



3. - As an option, you can activate a temporary licence for the selected application.

⇒ In the bottom area, you can see how long you have already been working with a temporary licence. You can test each application for 50 hours.

4. Use the „ME code“ to order a password from Müller-Elektronik.
5. Enter the password.
6. Restart the job computer.

⇒ The licence is now activated.

## 7.15

### Assigning the joystick buttons

If you are using the AUX2 auxiliary protocol, you can assign the buttons on the joystick yourself.

The buttons on the joystick can be assigned in the „Service“ application of the terminal. You can read how to do this in the operating instructions for the terminal.

The functions that can be assigned to the individual buttons can also be seen in the „Service“ application of the terminal. You can always recognise the respective function by the function icon.

The meaning of the respective function icons can be found in the different sections of these instructions.

## 8 Troubleshooting

### 8.1 Checking the software version

#### Procedure

To find out the software version:

1. Switch to the "Parameters" screen:



⇒ The software version will be shown.

## 9 Technical specifications

### 9.1 ECU-MIDI 3.0 job computer

|                           |                                                                                                                                                                                                                                                                                                     |
|---------------------------|-----------------------------------------------------------------------------------------------------------------------------------------------------------------------------------------------------------------------------------------------------------------------------------------------------|
| 1st processor:            | 32-bit ARM Cortex™-M4 CPU 168 MHz, 2048 KB flash; 256 KB RAM                                                                                                                                                                                                                                        |
| 2nd processor:            | 32-bit ARM Cortex™-M4 CPU 168 MHz, 2048 KB flash; 256 KB RAM                                                                                                                                                                                                                                        |
| External memory:          | SPI-Flash 16 MB; SDRAM 16 MB; FRAM 16 kByte                                                                                                                                                                                                                                                         |
| Connections:              | <ul style="list-style-type: none"> <li>▪ 42-pin connector for connecting actuators/sensors</li> <li>▪ 2x 16-pin connector for power supply and CAN</li> </ul> <p>The connectors can be locked and equipped with single conductor insulations.</p>                                                   |
| Interfaces:               | up to 3xCAN*                                                                                                                                                                                                                                                                                        |
| Power supply:             | 12 V electrical system (9-16 V), maximum current consumption 30 A                                                                                                                                                                                                                                   |
| Current consumption (IN): | 500 mA (at 14.4 V without power output, without supply to external sensors)                                                                                                                                                                                                                         |
| Standby current (OFF):    | 70 µA (typ.)                                                                                                                                                                                                                                                                                        |
| Temperature range:        | -40 ... +70 °C                                                                                                                                                                                                                                                                                      |
| Housing:                  | Anodized aluminium continuous cast casing, plastic lid with seal and pressure compensation element, stainless steel screws                                                                                                                                                                          |
| Protection rating:        | IP6K6K (with installed connectors)                                                                                                                                                                                                                                                                  |
| Environmental tests:      | <p>Vibration and shock testing in accordance with DIN EN 60068-2</p> <p>Temperature testing in accordance with IEC68-2-14-Nb, IEC68-2-30 and IEC68-2-14Na</p> <p>Protection testing in accordance with DIN EN 60529</p> <p>Electromagnetic compatibility according to DIN EN ISO 14982: 2009-12</p> |
| Dimensions:               | Approx. 262 mm x 148 mm x 62 mm (L x W x H, without connector)                                                                                                                                                                                                                                      |
| Weight:                   | ca. 1 kg                                                                                                                                                                                                                                                                                            |

\* Other interfaces upon request

## 9.2

## ECU-MAXI 3.0 job computer

|                        |                                                                                                                                                                                                                                                                                  |
|------------------------|----------------------------------------------------------------------------------------------------------------------------------------------------------------------------------------------------------------------------------------------------------------------------------|
| Main processor         | 32-bit ARM Cortex™-M3 CPU 120 MHz, 1024 KB flash; 128 KB RAM                                                                                                                                                                                                                     |
| 3x I/O processors      | 32-bit ARM Cortex™-M3 CPU 120 MHz, 256 KB flash; 96 KB RAM                                                                                                                                                                                                                       |
| External memory:       | SPI-Flash 2x 8 MB; SRAM 1 MB; EEPROM 16 Kbit; optional: FRAM 8/16 KByte                                                                                                                                                                                                          |
| Connections:           | <ul style="list-style-type: none"> <li>▪ 3x 42-pin connector for connecting of actuators/sensors</li> <li>▪ 2x 16-pin connector for power supply and CAN (ISOBUS &amp; Salve BUS)</li> </ul> <p>The connectors can be locked and equipped with single conductor insulations.</p> |
| Interfaces:            | External: up to 6 CAN interfaces and 3 LIN interfaces , Ethernet via additional card (optional)                                                                                                                                                                                  |
| Power supply:          | 12 V electrical system (50 A fuse)                                                                                                                                                                                                                                               |
| Power input (IN):      | 400 mA (at 14.4 V without power output, without supply to external sensors)                                                                                                                                                                                                      |
| Standby current (OFF): | 70 µA                                                                                                                                                                                                                                                                            |
| Temperature range:     | -40 to +85°C (in accordance with IEC68-2-14-Nb, IEC68-2-30 and IEC68-2-14Na)                                                                                                                                                                                                     |
| Housing:               | Anodized aluminium continuous cast casing, plastic lid with seal and stainless steel screws                                                                                                                                                                                      |
| Protection rating:     | IP66K                                                                                                                                                                                                                                                                            |
| Environmental tests:   | Vibration and shock testing in accordance with DIN EN 60068-2                                                                                                                                                                                                                    |
| Dimensions:            | 290 mm x 240 mm x 90 mm (L x W x H, without connector)                                                                                                                                                                                                                           |
| Weight:                | 3.0 kg                                                                                                                                                                                                                                                                           |

## 9.3

## Available languages

You can set the following languages in the software for the operation of the implement:

Bulgarian, Croatian, Czech, Danish, Dutch, English, Estonian, Finnish, French, German, Greek, Hungarian, Italian, Latvian, Lithuanian, Norwegian, Portuguese, Polish, Romanian, Russian, Serbian, Slovak, Slovenian, Spanish, Swedish, Turkish