

Installation and operating instructions

BASIC-Terminal



Version: V8.20191001



30322511-02-EN

Read and follow these instructions. Keep these instructions in a safe place for later reference. Please note that there might be a more recent version of these instructions on the homepage.

Company details

Document	Installation and operating instructions Product: BASIC-Terminal Document number: 30322511-02-EN As of software version: 04.10.04 Original instructions Original language: German
Copyright ©	Müller-Elektronik GmbH Franz-Kleine-Straße 18 33154 Salzkotten Germany Phone: ++49 (0) 5258 / 9834 - 0 Fax: ++49 (0) 5258 / 9834 - 90 Email: info@mueller-elektronik.de Homepage: http://www.mueller-elektronik.de

Contents

1	For your safety	6
1.1	Basic safety instructions	6
1.2	Layout and meaning of warnings	6
1.3	User requirements	7
1.4	Intended use	7
1.5	EC declaration of conformity	7
2	About these Operating Instructions	8
2.1	Target group of these Operating Instructions	8
2.2	Layout of operating instructions	8
2.3	Layout of references	8
3	Product description	9
3.1	Performance description	9
3.2	Scope of delivery	9
3.3	Information on the rating plate	9
4	Mounting and installation	11
4.1	Mounting the terminal in the tractor cab	11
4.1.1	Terminal ports	12
4.2	Connecting the terminal to the ISOBUS	12
4.3	Connecting the ISO printer to the terminal	13
4.4	Connecting the ME LightBar to the terminal	13
4.5	Connecting the on-board integrated display/controller to the terminal	14
4.6	Connecting the GPS Receiver to the terminal	15
4.7	Connecting sensors to the terminal	16
4.8	Connecting the camera to the terminal	17
5	Basic control principles	19
5.1	Getting to grips with the controls	19
5.2	Initial start-up	20
5.3	Configuration sequence	21
5.4	Using the function keys	22
5.5	Restarting the terminal	22
5.6	Inputting data	23
5.7	Using two terminals	23
6	Opening applications in the selection menu	25
6.1	Display layout in the selection menu	25
6.2	Opening applications	25
6.3	Segmentation of the display	26

7	Configuring the terminal in the Service application	28
7.1	Controls in the Service application	28
7.2	Icons in the Service application	29
7.3	Changing the language	29
7.4	Basic terminal settings	30
7.5	GPS receiver	31
7.5.1	Activating the GPS receiver	32
7.5.2	Configuring the GPS receiver	33
	Parameters for the GPS receiver	34
	RTK licence for SMART-6L	36
7.6	Configuring the "GPS TILT-Module" tilt module	36
7.7	Activating an external lightbar	37
7.8	Camera	37
7.8.1	Activating a camera	37
7.8.2	Operating the camera	38
7.9	Configuring the joystick button allocations	39
7.10	Adjusting the brightness for day or night mode	42
7.11	Activating and deactivating applications	42
7.12	Activating licenses for full versions of the software	43
7.13	Setting the purpose of the terminal	44
7.14	Deleting files from the USB memory device	45
7.15	Deleting pools	45
7.16	Activating the "Diagnostics" function	46
7.16.1	Diagnostics	47
7.17	Screenshots	47
7.17.1	Configuring the screenshots function	47
7.17.2	Creating screenshots	48
7.18	CAN-Trace settings	48
7.19	Activating ISO Printer	49
8	Tractor-ECU application	50
8.1	Add a vehicle profile	50
8.2	Configuring the parameters for a vehicle profile	51
8.2.1	Calibrating the speed sensor	55
8.2.2	Configuring a working position sensor	55
8.2.3	Entering the position of the GPS Receiver	57
	For machines fitted with an ISOBUS job computer	58
8.3	Activating vehicle profiles	59
9	ISOBUS-TC task processing	60
9.1	Using ISOBUS-TC	60
9.2	Adjusting how you use ISOBUS-TC	60
9.3	Configuring the list of connections	61

10	Serial Interface application	62
10.1	Transfer target rates via LH5000	62
10.2	Switching sections and transferring target rates via ASD	63
11	FILE-Server application	66
12	Maintenance and servicing	67
12.1	Servicing and cleaning the terminal	67
12.2	Disposing of the unit	67
12.3	Instructions on retrofitting	67
12.4	Checking the software version	68
12.5	Technical specifications	68
12.5.1	Technical specifications of the terminal	68
12.5.2	Pin assignment of port A	69
12.5.3	Pin assignment of port B	70
12.5.4	Pin assignment of port C	71
12.5.5	Pin assignment of camera ports 1 and 2	72
13	Notes	74

1 For your safety

1.1 Basic safety instructions



Please read the following safety instructions carefully before using the product for the first time.

- Do not operate the terminal while driving in road traffic. Come to a standstill in order to use the unit.
- Before maintaining or repairing the tractor, always disconnect the connection between the tractor and the terminal.
- Before charging the tractor battery, always disconnect the connection between the tractor and the terminal.
- Before welding on the tractor or implement, always disconnect the power supply to the terminal.
- Do not make any unauthorized modifications to the product. Unauthorized modifications or use may impair safety and reduce the service life or operability of the unit. Modifications are considered unauthorized if they are not described in the product documentation.
- Follow all recognised safety, industrial and medical rules as well as all road traffic laws.
- The product does not include any user serviceable parts. Do not open the casing.
- Read the operating instructions to the agricultural device which you want to control by using the product.



Using a camera

The camera serves **solely** for observing the implement functions in non-safety-related working areas of the agricultural implement.

In certain situations, the camera image may appear on the screen with a delay. The delay depends on the respective use of the terminal and can also be affected by external factors and devices.

For this reason, please note the following information:

- Do not use the camera to assist with steering the vehicle: not in road traffic, and not on private properties.
- Do not use the camera to watch the road traffic or when driving into intersections.
- Do not use the camera as a rear view camera.
- Do not use the camera as a visual aid for controlling the implement, especially when a delayed reaction can lead to risks.
- Using a camera does not exempt you from your due diligence obligation to pay attention to safety when operating the implement.

1.2 Layout and meaning of warnings

All safety instructions found in these Operating Instructions are composed in accordance with the following pattern:

	WARNING
	This signal word identifies medium-risk hazards, which could potentially cause death or serious physical injury, if not avoided.



CAUTION

This signal word identifies low-risk hazards, which could potentially cause minor or moderate physical injury or damage to property, if not avoided.

NOTICE

This signal word identifies actions which could lead to operational malfunctions if performed incorrectly.

These actions require that you operate in a precise and cautious manner in order to produce optimum work results.

There are some actions that need to be performed in several steps. If there is a risk involved in carrying out any of these steps, a safety warning appears in the instructions themselves.

Safety instructions always directly precede the step involving risk and can be identified by their bold font type and a signal word.

Example

1. **NOTICE! This is a notice. It warns that there is a risk involved in the next step.**
2. Step involving risk.

1.3

User requirements

- Learn how to operate the terminal correctly. The terminal may not be operated by anyone who has not read the Operating Instructions.
- Please read and carefully observe all safety instructions and warnings contained in these Operating Instructions and in the manuals of any connected vehicles and farm equipment.

1.4

Intended use

The terminal is intended exclusively for use in agriculture as well as in wine-growing, fruit-cultivating, and hop-growing operations. The manufacturer cannot be held responsible for any installation or use of the terminal that deviates from or exceeds the scope of intended use.

The manufacturer cannot be held liable for any personal injury or property damage resulting from such improper use. All risks involved in engaging in improper usage, lie solely with the user.

Intended use also includes compliance with the conditions for operation and repairs prescribed by the manufacturer.

The manufacturer cannot be held liable for any personal injury or property damage resulting from such non-compliance. All risk arising from improper use lies with the user.

All applicable accident prevention regulations and all other generally recognized safety, industrial, and medical standards as well as all road traffic laws must be observed. Any unauthorized modifications made to the equipment will void the manufacturer's warranty.

1.5

EC declaration of conformity

This product has been manufactured in conformity with the following national and harmonised standards as specified in the current EMC Directive 2004/108/EC:

- EN ISO 14982

2 About these Operating Instructions

2.1 Target group of these Operating Instructions

These Operating Instructions are intended for personnel entrusted with installing and operating the terminal.

2.2 Layout of operating instructions

The operating instructions explain step by step how you can perform certain operations with the product.

We use the following symbols throughout these Operating Instructions to identify different operating instructions:

Type of depiction	Meaning
1. 2.	Actions that must be performed in succession.
⇒	Result of the action. This will happen when you perform an action.
⇨	Result of an operating instruction. This will happen when you have completed all steps.
☑	Requirements. In the event that any requirements have been specified, these must be met before an action can be performed.

2.3 Layout of references

If any references are given in these Operating Instructions, they appear as:

Example of a reference: [→ 8]

References can be identified by their square brackets and an arrow. The number following the arrow shows you on what page the section starts where you can find further information.

3 Product description

3.1 Performance description

Software

All applications of Müller-Elektronik available are installed on the terminal. But first you must activate some of them.

See also: Activating licenses for full versions of the software [→ 43]

The following applications are activated:

- SERVICE – this application configures the terminal.
- ISOBUS-UT - interface for controlling ISOBUS-job computers. The terminal is compliant with ISOBUS standard ISO 11783. This terminal can be used as the control unit independently of the manufacturer as an independent terminal on all machines that meet the requirements of this ISOBUS standard.
- Tractor-ECU - this application enables you to configure all sensors connected to the terminal and to input the position of the GPS receiver.
- FILE-Server - This application is used to define a save location on the terminal. This save location can be used by all ISOBUS implements which do not have their own USB interface.
- Serial Interface - This application enables a data exchange between the terminal and an on-board integrated display/controller via the serial interface. In this way, you can also use the GPS signal for machines which are not ISOBUS-compatible. You can transfer target rates to the on-board integrated display/controller or switch sections. The data is sent using the LH5000 or ASD protocols.
 - If you want to use the ASD protocol, you must activate the "ASD-Protocol" license.

You can test the following application for 50 hours free of charge:

- TRACK-Leader – a modern system enabling the driver of an agricultural vehicle keep exact parallel lanes on the field.
- SECTION-Control – automatic boom section switching. Additional module for TRACK-Leader.
- VARIABLE RATE-Cont. – with this application you can work with prescription maps saved as shp files. Additional module for TRACK-Leader.
- TRACK-Leader TOP – automatic steering. Additional module for TRACK-Leader.
- FIELD-Nav – this is the first navigation software that contains all navigable paths, takes movement restrictions into account and leads directly to the field or other agricultural destination.

The following applications are installed, but deactivated until you have activated a license:

- ISOBUS-TC – this is the certified ISOBUS task controller from Müller Elektronik. In this application you can use the terminal for processing all tasks previously planned on the PC.

3.2 Scope of delivery

The following items are included in delivery:

- Terminal
- Installation and Operating Instructions
- Bracket for mounting the terminal
- USB memory device

3.3 Information on the rating plate

You will find a nameplate sticker on the back of the terminal. On this sticker, you can find all the information you need to definitively identify the product.

Have these details ready when you contact Customer Services.

Abbreviations on the rating plate

Abbreviation	Meaning
SW:	Software version You can see the installed software version on the Start Screen of the Service application:
HW:	Hardware version
DC:	Operating voltage The terminal may only be connected to voltages within this range.
K.-Nr.:	Customer number If the terminal was manufactured for an agricultural machinery manufacturer, the agricultural machinery manufacturer's item number will be shown here.
SN:	Serial number

4 Mounting and installation

Mount the terminal and all additional components in the following order:

1. Mount the terminal in the vehicle cab.
2. Connect the terminal to the ISOBUS. [→ 12]
3. Connect the terminal to the GPS receiver.
4. Connect the terminal to other components.

4.1 Mounting the terminal in the tractor cab

NOTICE

Electromagnetic interference

The operation of the terminal may be impaired by electromagnetic waves emitted by other farm equipment.

- Mount the terminal at least 1 m away from the radio antenna or from a radio device.

Procedure

1. Screw the bracket to the terminal.

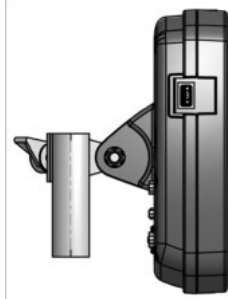

2. Mount the terminal with the bracket installed inside the tractor cab.
For instance, you can use the ME base console for this purpose.
The base console is not included in the terminal delivery. It belongs to the delivery scope of ISOBUS basic equipment.

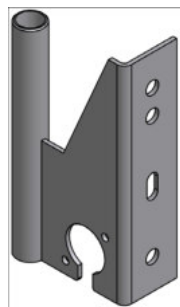

Base console

4.1.1 Terminal ports

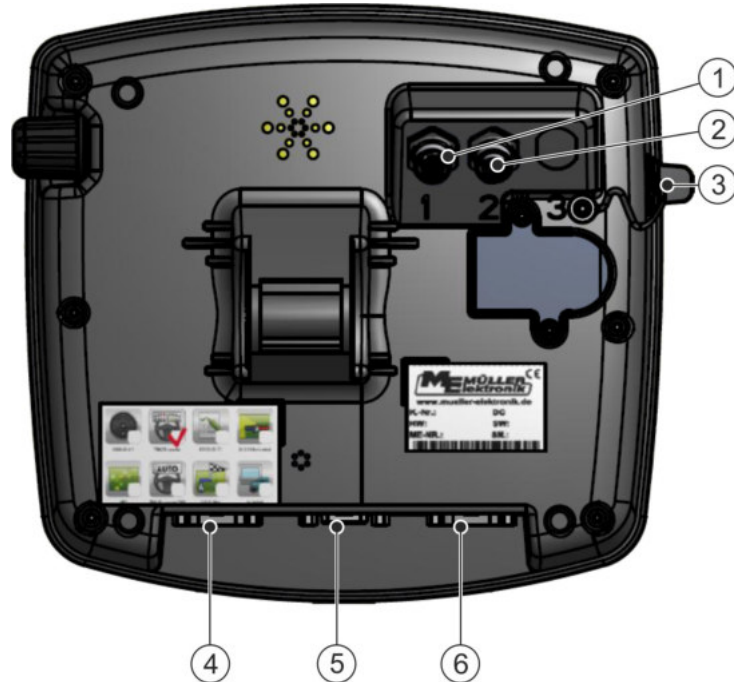

Rear of the terminal. Version with camera connections

①	Port for analog camera (optional)	④	Port B See section: Pin assignment of port B [→ 70]
②	Port for analog camera (optional)	⑤	Port A CAN Bus port To connect to the power supply or the tractor ISOBUS.
③	USB port USB 1.1	⑥	Port C RS232 serial port for: - GPS receiver - GPS TILT-Module - Lightbar

4.2 Connecting the terminal to the ISOBUS

In order to be able to operate an ISOBUS job computer with the terminal, you must connect the job computer to the ISOBUS.

You will need a different connection cable for this, depending on the model of your tractor.

- In tractors which have been subsequently upgraded with an ISOBUS-basic vehicle harness from Müller-Elektronik, use connector cable A from the ISOBUS-basic vehicle harness.
- In tractors which are equipped as standard with ISOBUS and which have an ISOBUS In Cab Connector, you will need the following connector cable:
 - D-Sub <-> CPC connector cable, item no. 30322541



- In tractors which are fitted with their own ISOBUS terminal, but in which there is however no ISOBUS In Cab Connector, you can ask for the ISOBUS In Cab Connector to be retrofitted.
 - You can order the appropriate cable from Müller-Elektronik. Our sales team will be glad to advise you.
 - For certain tractors, you can retrofit the connector cable without the ISOBUS In Cab Connector.
 - In certain versions, you will also require the D-Sub <-> CPC connector cable, item no. 30322541

When there is more than one terminal in the tractor cab, you may need to change certain settings in order to enable two-way communication. Find out more: Using two terminals [→ 23]

Procedure

1. Connect the 9-pin connector A of the basic vehicle harness to port A of the terminal.
2. Tighten the safety screws on the connector.

4.3

Connecting the ISO printer to the terminal

The ISO printer is used to print out information from an ISO-XML task.

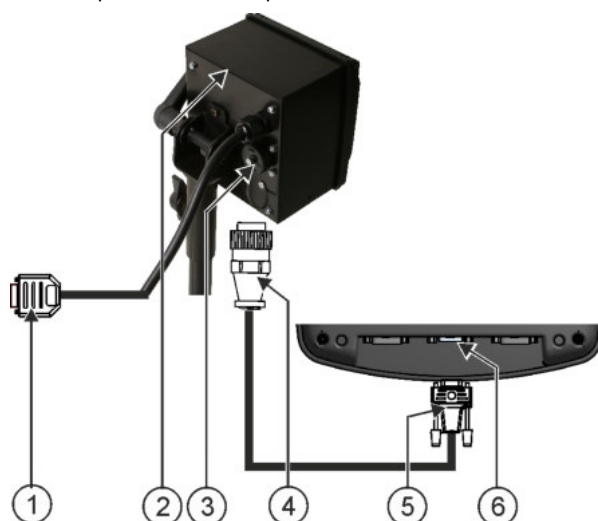

①	9-pin Sub-D connector for connection to ISOBUS	④	Connector for connection to ISO printer socket
②	ISO Printer	⑤	Connector for connection to the terminal
③	ISO Printer socket	⑥	CAN Bus port

When you connect a GPS receiver to the terminal, you must activate [→ 49] and configure it.

4.4

Connecting the ME LightBar to the terminal

The ME LightBar is a parallel guidance display made by Müller-Elektronik, which can be mounted near the windshield.

The ME LightBar works with position data and guidance lines that are provided by the TRACK-Leader app. This is why you need the TRACK Leader App to be able to use the ME LightBar.

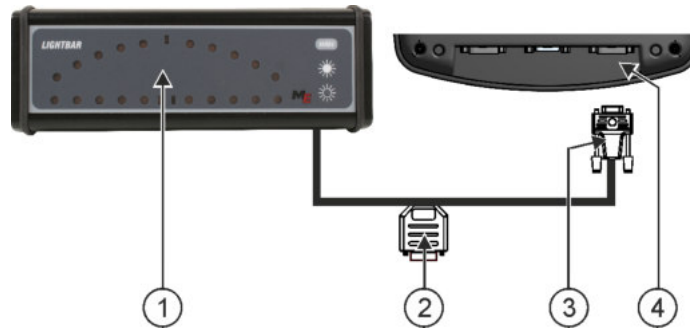

①	External LightBar	③	Connector for connection to the terminal
②	Plug for connecting a GPS receiver	④	Serial port RS232

After connecting an external LightBar to the terminal, you must activate [→ 37] it.

4.5

Connecting the on-board integrated display/controller to the terminal

You can connect a range of on-board integrated display/controllers (non-ISO computers), which communicate using the LH5000 protocol or the ASD interface, to the terminal.

An appropriate connector cable for each on-board integrated display/controller which can be connected is available from Müller-Elektronik. Our sales team will be glad to advise you.

You can find a list of on-board integrated display/controllers that we have tested here:

- Transfer target rates via LH5000 [→ 62]
- Switching sections and transferring target rates via ASD [→ 63]

For other on-board integrated display/controllers and for on-board integrated display/controllers with other software versions, this function may not work at all or different from how it is described in these instructions. Because the operating mode and configuration depends on the on-board integrated display/controller, Müller-Elektronik can unfortunately not help you with their set-up. You must contact the on-board integrated display/controller manufacturer for this.

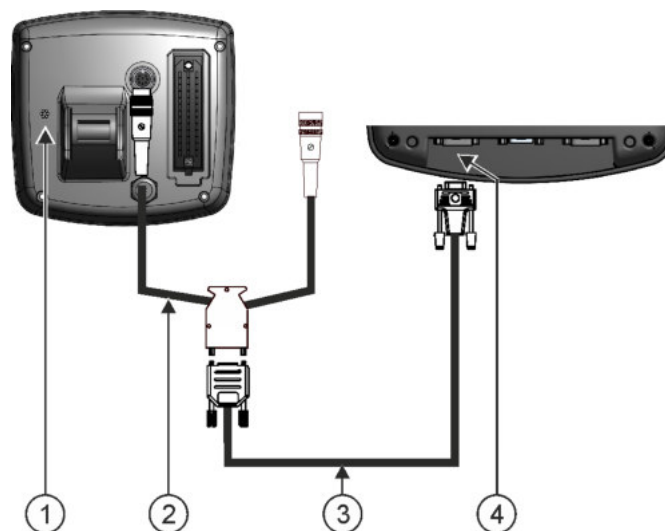

①	On-board integrated display/controller	③	Null modem cable
②	Adapter cable* Available as a set with Cable 3, item number: 3032254800	④	Connector B of the terminal

*When using an Amatron3 or Amatron+ as on-board integrated display/controller, you will only need a traditional null modem cable. (Amatron3 and Amatron+ are on-board integrated display/controller from Amazone)

4.6



Connecting the GPS Receiver to the terminal

Requirements

Each GPS receiver which is connected to the terminal must fulfil the conditions in the table below. GPS receivers which can be purchased from Müller Elektronik fulfil these conditions.

Technical requirements for using the DGPS Receiver

Operating voltage:	Supply voltage of the terminal – 1.5 V
Current consumption	Maximum of 200 mA (at 70 °C) without any additional load from other appliances (the current consumption of the multifunctional grip and LightBar have already been taken into account in this specification.)
GPS standard	NMEA 0183
Refresh rates and signals	5 Hz (GPGGA, GPVTG)
	1 Hz (GPGSA, GPZDA)
Transmission rate	19200 baud
Data bits	8
Parity	no
Stop bits	1
Flow control	none

	 CAUTION
	<p>Damage to the equipment caused by short circuit</p> <p>Pin 4 of port C is live. The voltage depends on the operating voltage of the terminal and is used to supply the DGPS Receiver from Müller Elektronik.</p> <p>Other GPS Receivers may suffer damage if connected to this port.</p> <p>Before connecting a different GPS Receiver:</p> <ul style="list-style-type: none"> ◦ Check what voltage the terminal is connected to (12 V or 24 V). ◦ Check the pin assignment of the GPS Receiver. ◦ Check the allowable voltage for the GPS Receiver. ◦ Compare the terminal voltage to the allowable voltage for the GPS Receiver. ◦ Compare the pin assignment. ◦ Only connect the GPS Receiver to the terminal, if the voltage range and pin assignment of both devices don't differ from each other.

During initial start-up it can take approx. 30 minutes until the GPS Receiver has reception. At subsequent start-ups it will only take approx. 1-2 minutes.

Procedure

- The GPS receiver is mounted on the roof of the tractor.
- You have activated a suitable driver.
- 1.  - Switch off the terminal.
- 2. Guide the connection cable from the GPS receiver into the cab.
- 3. **CAUTION! Ensure that the cable is not laid across sharp edges or at risk of becoming bent. Lay the cable in a place where nobody can trip over it.**
- 4. Connect the connecting cable of the GPS receiver to port C on the terminal.

4.7

Connecting sensors to the terminal

The terminal provides you with the possibility of connecting a sensor or the tractor's 7-pin signal socket to port B. This allows you for example to use the work position signal in the TRACK-Leader parallel guide.

Most sensors which can be purchased from Müller Elektronik are fitted with a round 3-pole plug. In order to connect this to the terminal, you will need an adapter cable. A different adapter cable is needed for each hardware version of the terminal.

Adapter cable dependent on hardware version

Terminal hardware version	Adapter cable	Connection	Item number
As of 3.0.0	3-pin connector	Adapter cable, 9-pin bushing to 3-pin	31302499
From 1.4.1	3-pin connector	Adapter cable, 9-pin socket to 3-pin	31302497

You can also connect the terminal to the signal socket.

Cable to the signal socket

Terminal hardware version	Ports	Connection	Item number
As of 3.0.0	7-pin to 9-pin socket	Cable directly to the signal socket Transfers the speed, PTO revolution, work position.	30322548
All	3-pin (from the adapter cable, dependent on the hardware version) to 7-pin.	Cable to the signal socket Only transfers the work position.	313008

4.8

Connecting the camera to the terminal



Camera with cable harness

①	Connection to the terminal	③	Camera
②	Cable for connection to the voltage supply. GND (blue) - Ground +12V (brown) - 12V voltage	④	Camera connector
		⑤	Socket for connection to the camera connector

Procedure

1. Assemble the camera together with its bracket, as described in the assembly instructions of the camera manufacturer.
2. Connect the camera to the cable harness.
3. **CAUTION!** When laying out the cable harness, you should ensure that no kinks form in the cable, and that no one can trip over the laid-out cable.

4. Connect the junction of the cable harness to a power source (12V). Müller-Elektronik offers different connectors for this purpose, which you can connect to the cable.
5. Connect the cable harness to the camera connection of the terminal.
6. Secure the camera.
7. Activate the camera. [→ 37]

5 Basic control principles

5.1 Getting to grips with the controls



Terminal controls

①	Rotary knob	③	Keys
②	Function keys		

Controls

Rotary knob

The rotary knob is located in the top right hand corner of the terminal.

Control with the rotary knob may vary slightly between the different applications.

You can use the rotary knob to perform the following actions:



Turning the rotary knob:

- Move the cursor up and down.
- Change a parameter value.



Pressing the rotary knob:

- Click on the selected line.
- Activate parameter.
- Confirm input.





Function keys

Operating the function keys is the same across all applications.



Performing the functions depicted on the display

Keys



-  Switch the terminal on and off
-  Has no function
-  Has no function
-  Exit screen
Cancel input
Hide warning messages and alerts
-  Open the "Selection menu" application
Exit the "Selection menu" application

5.2

Initial start-up

Procedure

This is how you start the terminal for the first time:

- You have mounted and connected the terminal.
- 1.  - Switch on the terminal.
- 2. Wait for approx. 15 seconds until all applications have been loaded.
- 3.  - Open the "Selection menu" application.

⇒ The following screen will appear:



- ⇒ You are now in the selection menu.
- ⇒ When the terminal is connected to an ISOBUS job computer, they will be now loaded. The progress of this process is indicated by the progress bar next to the job computer icon. The time taken to complete this process depends on the number of connected job computers.
- 4. Wait until all job computers have been loaded.

⇒ The following screen will appear:



The job computers are loaded when no more progress bars are displayed.

5. In the selection menu you can select which application you wish to display next.

6.  - Select the "Service" line. The "Service" line must be framed by a black square:



7.  - Click on the "Service" line.

⇒ The following screen will appear:

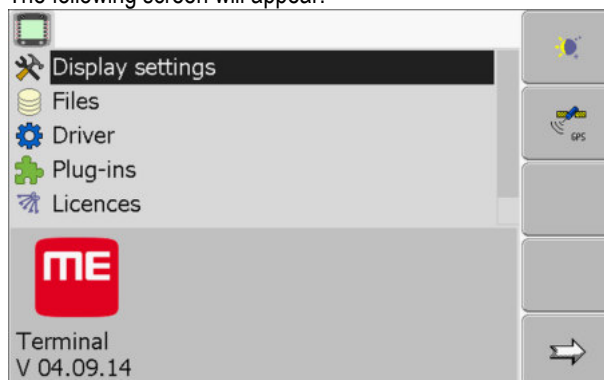

⇒ You have opened the "Service" application.

8. Configuring the terminal in the Service application [→ 28]

5.3

Configuration sequence

Depending on the terminal that you have and which apps are activated, you will need to configure the terminal and its accessories in different points.

You must make these settings during the initial commissioning:

- Activating the GPS receiver [→ 32]
- Configuring the GPS receiver [→ 33]
- Entering the position of the GPS Receiver [→ 57]
- Adjusting how you use ISOBUS-TC [→ 60]



Once you have made these settings, the terminal is ready to operate.

Note however that you will need to configure the TRACK-Leader and FIELD-Nav applications in detail. To do this, read the instructions for these applications.

The number of settings is dependent on the number of functions that you are using, and which machines are operated with the terminal.

5.4 Using the function keys

Whenever you use the function keys, you will activate the function depicted on the adjacent function icon.

	 CAUTION
	<p>Danger of pressing the function keys without care</p> <p>When pressing function keys, components of the connected machine can be moved or activated. As a result, people can be injured and property damaged.</p> <p>Before pressing a function key:</p> <ul style="list-style-type: none"> ◦ Make sure you know what will happen when you press the function key. ◦ Consult the Operating Instructions of the connected machine or of the agricultural equipment to establish what dangers could arise from pressing that key. ◦ Fulfill all the measures described in the machine's Operating Instructions in order to avoid danger. ◦ Only press the function key when you are sure that no danger is posed to people or property.

When you press a function key, the function / operation depicted on the function icon will be performed.

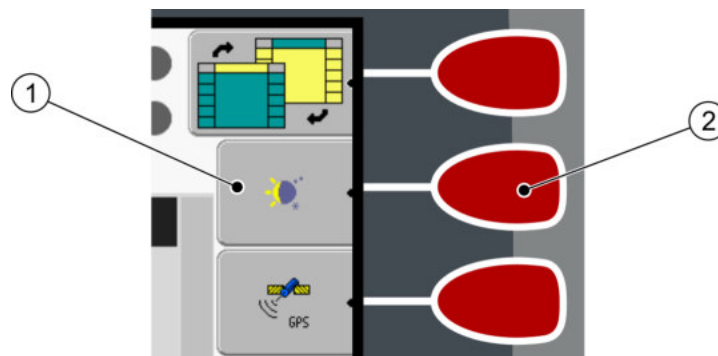

Using the function keys

①	<p>Function icon</p> <p>Depiction of an available function.</p>	②	<p>Function key</p> <p>Performs the function depicted on the function icon.</p>
---	--	---	--

Example



When you press the function key ②, the function depicted on the function icon ① will be activated.

If not function icon appears next to a function key, this means that this function key has no function at present.

5.5 Restarting the terminal

When restarting the terminal, you must give the connected jobcomputers enough time to restart as well. For this reason, always wait approx. 30 seconds after switching off the terminal before switching the terminal back on.

Procedure

1.  - Switch off the terminal.
2. Wait 30 seconds until the jobcomputers have also been switched off.
3.  - Switch on the terminal.

5.6

Inputting data



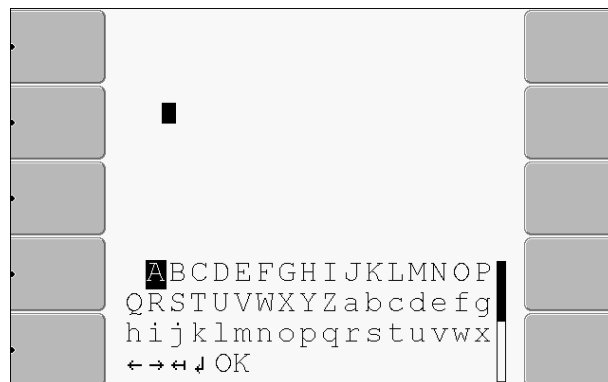

All data must be entered on the data input screen.



Data input screen

Controls



Below the characters, you will find 5 icons which will assist you when entering the data.

-  Delete characters
-  Move cursor to the left
-  Move cursor to the right
-  Confirm and finish input.
-  No function

Procedure

This is how you enter the data:

- The data input screen has been opened:

1.  - Select the desired character.
2.  - Click on the selected character.
3. When all characters have been entered, select the "OK" symbol with the rotary button and click.
⇒ The input will be applied.

5.7

Using two terminals

The following table will tell you which settings you need to configure to be able to use two terminals, and the sections in which these are described. The specifications on the in-cab terminals are without liability.

Parameter	Chapter
Run as auxiliary terminal	Setting the purpose of the terminal [→ 44]
Login as ISOBUS-UT	Setting the purpose of the terminal [→ 44]
Connection with ISOBUS-TC?	Configuring the parameters for a vehicle profile [→ 51]
List of connections	List of connections [→ 61]

6 Opening applications in the selection menu

In the selection menu you can choose which application you wish to view on the display.

You can open the selection menu at any time. This will not close the application currently running.

Controls



Open the selection menu



Press again – open the most recently activated application

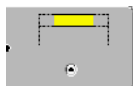

Display the application in the header of the split display.

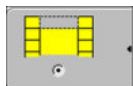

Display the application in the main section of the display.

6.1

Display layout in the selection menu

The display is split into the following sections:

- Function icons – left and right
- Applications section – in the middle, between the function icons.



Sections in the selection menu

①	Name of an application	④	ISO ID of the application ISO name of the application
②	Function icons on the left Select an application which will later be displayed in the header.	⑤	Selection The selected application is displayed on the main display.
③	Selection The selected application is displayed in the header	⑥	Function icons on the right Open an application on the main display.
		⑦	Cursor Open the selected application using the rotary knob.

6.2

Opening applications

You can perform the following actions in the selection menu:

- Open an application.
- Display an application in the header of the split display.

Procedure

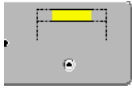
-  - Set which application is to be displayed in the header of the split display.
 ⇒ The function icon of the selected application is marked with a dot on the left hand side:

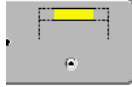

- Start the application for the main display. There are several ways to do so:
 - With the rotary knob:



- Select the desired application



- Open the selected application

- Using the function keys on the right hand side:

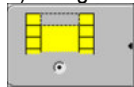

- Display the application shown next to the function icon.

⇒ Both applications will appear on the display.

6.3

Segmentation of the display

The display of the terminal is split into two sections.

A different application is displayed in each section. This allows you, for example, to control the tractor on the field and monitor the field sprayer at the same time. This means that you will not need an additional terminal.

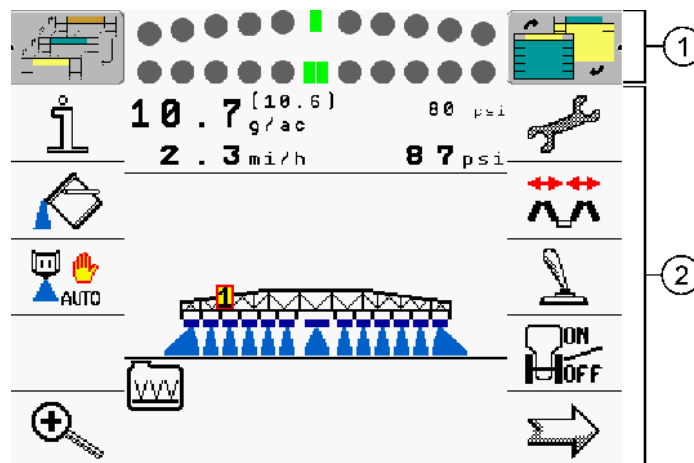

Segmentation of the display

①	Header – informative section. The header allows you to display information from an application.	②	Main screen – section used for control. The main display shows the application currently running, function icons and the information you need to control the application that is currently running.
---	---	---	---

In the selection menu you can see which applications can be run with the split display.

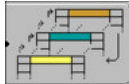
Function icon	Function
	Switch applications in the header section.

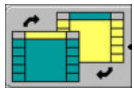
Function icon	Function
 The icon depicts a rectangular display area divided into a top header section and a larger main section. A yellow rectangular block is shown overlapping the boundary between the two sections. Two curved arrows, one pointing from the header to the main section and another pointing from the main section to the header, indicate a swapping or exchange of content between the two areas.	Swap applications between the header section and the main section of the display.

7 Configuring the terminal in the Service application

In the "Service" application you can configure the terminal and activate the connected farm equipment.

Once you have launched the "Service" application, you will be shown the following screen:

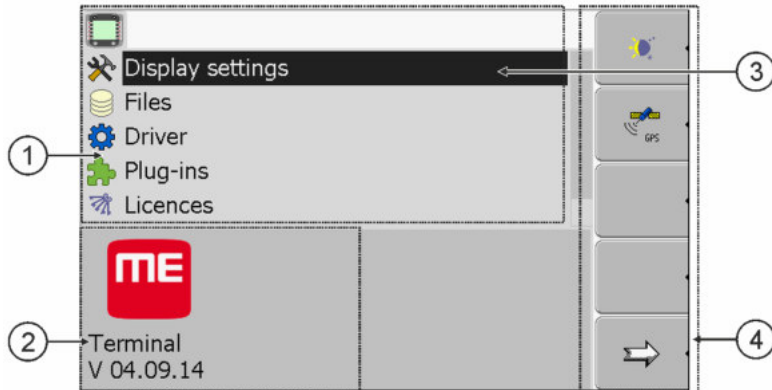

Start screen of the "Service" application

① Main section Screen contents	③ Cursor Selects a line that can be clicked on with the rotary knob.
② Version number Name of the terminal and version of the installed software	④ Function icons section Icons that can be pressed on this screen.







7.1 Controls in the Service application

The Service application is controlled using the rotary knob and the function buttons.

Controls

Some of the function icons explained here will only appear if a specific function is activated. This limits the information shown on the terminal to just the information that you need for your work.

Function icon	Meaning	Only appears if...
	Scroll	There is one more page with function icons.
	Return	
	Activate day mode	
	Activate night mode	
	File cannot be deleted (grey)	Selected object cannot be deleted

Function icon	Meaning	Only appears if...
	Delete file (red)	Selected object can be deleted
	Configure GPS receiver	GPS receiver is activated
	Configuring farmPilot	farmPilot portal is activated
	Open the Diagnostics screen	Diagnostics is activated
	Retrieve default values.	
	Display DGPS connection status	
	Associating the buttons on a joystick with functions	Driver "Auxiliary2" is activated

7.2

Icons in the Service application

You will find the following icons in the Service application.

Icons



Function is activated



Function is deactivated



7.3

Changing the language

If you change the language in the Service application, you also change the language for all applications and the ISOBUS job computer.

If a connected ISOBUS job computer cannot activate the selected language, a standard language will be activated.

Procedure

-  - Switch on the terminal.
-  - Press.

⇒ The following screen appears:



3. - Click on "Service".

⇒ The following screen appears:

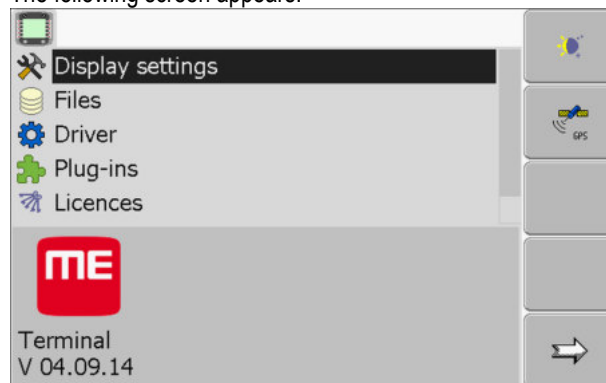

The texts in this screen can appear in a foreign language.

4. - Click on "Terminal settings".

5. - Click on "Language".

6. - Select the abbreviation of your language.

7. - Press.

⇒ The following message appears: "Restart the terminal."

8. - Press.

⇒ The language in the "Service" application will be changed. The language in other applications will only be changed after a terminal restart.

9. - Restart the terminal.

⇒ The language in other applications will be changed.

7.4 Basic terminal settings

The basic settings include: Language, Time, Measurement units.

All settings which you make here will also apply to other applications and in connected ISOBUS job computers.

Procedure

1. Switch to the "Terminal settings" screen:



| Service | Terminal settings

⇒ The following screen appears:

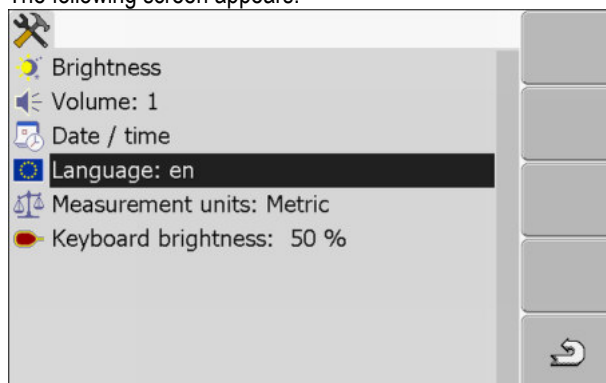

2. - Modify the required parameters.

List of parameters

Parameter	Sub-parameter	Meaning
Brightness	Day	Adjusting brightness for day mode
	Night	Adjusting brightness for night mode
	Night mode	Switching night mode on and off 0 = day mode is activated 1 = night mode is activated
Volume		Adjust volume
Date / time	Date	Setting current date
	Time	Setting current time
	Time zone	0 = Time zone: Greenwich Mean Time (GMT) 1 = GMT +1 hour (Germany) -1 = GMT -1 hour
Language		Selecting the language
Measurement units	Metric	Displays all units in metrical system
	Imperial	Displays all units in imperial system
	US	Displays all units in US system
Keyboard brightness		Setting the level of keyboard brightness in percent

7.5

GPS receiver

When you connect a GPS receiver to the terminal, you must activate and configure it.



7.5.1 Activating the GPS receiver

In order to enable the GPS receiver, you must first select the driver for the connected receiver.

A driver is a small program that controls connected device. The drivers for the devices supplied by Müller-Elektronik are pre-installed on the terminal.

Available drivers

Driver name	GPS receiver
deactivated	No GPS receiver is connected.
PSR CAN	Select this driver if the GPS receiver is connected to the PSR steering job computer. PSR is a steering job computer by the Reichhardt company. The signals are transmitted to the terminal through the CAN cable. The receiver will be configured directly in the PSR application.
A100, A101	Drivers for the A100 and A101 GPS receivers from Müller-Elektronik, if they are connected to the serial interface.
Standard	Drivers for unknown GPS receivers, if they are connected to the serial interface. This driver is activated by default. The connected GPS receiver cannot thus be configured.
AG-STAR, SMART-6L	Drivers for the AG-STAR and SMART-6L GPS receivers from Müller-Elektronik, if they are connected to the serial interface.

	 CAUTION
	<p>Incorrect driver Damage to the GPS receiver.</p> <ul style="list-style-type: none"> ◦ Before connecting a GPS receiver to the terminal, you must always activate the appropriate driver.

Procedure

1. Switch to the "Driver" screen:



⇒ The following screen will appear:



2. Select "GPS".
 3. Click on "GPS".
- ⇒ The installed drivers will appear.



⇒ The  icon will appear next to the active driver.

4. Mark the line with the correct driver.
5. Click on the selected line.

⇒ The following icon will appear next to the driver .

6.  - Restart the terminal.
- ⇒ GPS receiver is activated.
 ⇒ The following function icon will appear in the start screen of the "Service" application:



⇒ You have activated the GPS receiver.



7.5.2

Configuring the GPS receiver

The internal software for each GPS receiver must be configured. You can configure the following GPS receivers offered by Müller-Elektronik via the terminal:

- A100, A101
- AG-STAR, SMART-6L

All other GPS receivers must be configured in accordance with their manufacturer's instructions.

Function icon	Function
	Reset the configuration of the DGPS receiver to default values
	Display DGPS connection status

Procedure

To configure the parameters:

- A GPS receiver is connected to socket C of the terminal.
- The GPS receiver is connected directly to the terminal. Additional devices such as ME LightBar or tilt module may **not** be connected in between.
- The appropriate driver is activated.

- The driver of the ME Lightbar “LightBar” is deactivated. Otherwise the DGPS receiver cannot be configured.

1. Switch to the “GPS” screen:



⇒ The following screen appears:

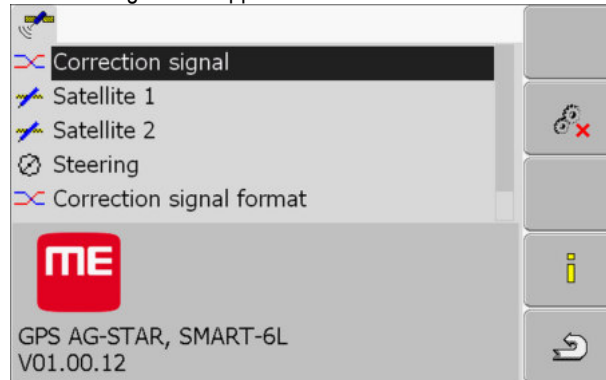

2.  - Click on the desired parameter. First of all, set the “Correction signal” parameter.

⇒ A selection list appears.

3.  - Select the desired value.

⇒ The  icon appears next to the value.

4.  - Back.

⇒ For some parameters it is necessary to restart the terminal. In these cases, the following message appears:

“Restart the terminal.”

⇒ You have configured the DGPS receiver.

5. Reconnect all of the additional devices that you had disconnected for the configuration.

Parameters for the GPS receiver

Baud rate

Only appears when the “Standard” driver is selected.

Setting for the speed at which the GPS receiver sends data to the terminal. The parameter sets the baud rate for the terminal.

Satellite 1 and Satellite 2

Satellite 1 – primary DGPS satellite. The DGPS receiver will connect to this satellite in the first instance.

Satellite 2 – secondary DGPS satellite. The DGPS receiver will only connect to this satellite in the event that the primary satellite fails.

Your satellite selection will depend on which satellite currently has the best availability in your region.

Possible values:

- "Auto"

The software automatically selects the current best satellite. This setting is not recommended, as it slows down the start-up of the DGPS receiver.

- Name of the satellite. Which satellites are shown here is dependent on the driver and correction signal that you have activated.

Steering

This parameter activates the "Automatic steering" assistance function in the GPS receiver.

If you want to connect your existing GPS receiver to a steering job computer, you have to configure the "Steering" parameter.

Possible values:

- "On"
Activates automatic steering assistance.
- "Off"
Deactivates automatic steering assistance.

Correction signal

Type of correction signal for the DGPS receiver.

The correction signals which are available is dependent on the activated driver.

Possible values:

- For the "A100, A101" driver:
 - "WAAS/EGNOS"
Correction signal for Europe, North America, Russia and Japan.
 - "E-DIF"
Internal calculation of correction data.
Only functions with a special version of the A100 DGPS receiver, item no. 30302464. This receiver is no longer sold by Müller-Elektronik.
- For the "AG-STAR, SMART-6L" driver
When a AG-STAR DGPS/Glonass receiver is connected:
 - "EGNOS-EU"
 - "WAAS-US"
 - "MSAS-JP"
 - "EGNOS-EU + GL1DE"
 - "WAAS-US + GL1DE"
 - "MSAS-JP + GL1DE"
 - "GPS/Glonass GL1DE 1"
 - "GPS/Glonass GL1DE 2"

When a SMART-6L DGPS/Glonass receiver is connected:

- EGNOS/WAAS
- EGNOS/WAAS + GL1DE
- GL1DE
- RTK radio (RTK license required [→ 36])
- RTK GSM (RTK license required [→ 36])

Correction signal format

Format of correction signal for the SMART-6L DGPS/GLONASS receiver.

Only appears when "RTK radio" or "RTK GSM" correction signals have been selected.

Possible values:

- RTCM V3
- CMR/CMR+
- RTCA

For the correction signal format which you must select, please refer to your correction service.

Tilt module

The GPS TILT-Module is configured using this parameter.

You can order the tilt module from Müller Elektronik with the following item number: 30302495.

RTK licence for SMART-6L

You will need a SMART-6L DGPS/GLONASS receiver and RTK license in order to work with RTK correction signals.

The RTK license is inserted by Müller-Elektronik. You will need to either order a license at the same time as you order the receiver, or send in your receiver.

7.6

Configuring the "GPS TILT-Module" tilt module

Procedure

- The "GPS TILT-Module" tilt module is connected.
 - The tractor is positioned on level ground.
 - The driver of the external ME-Lightbar is deactivated.
1. If additional devices (e.g. ME-Lightbar) are connected to the cable between the terminal and the tilt module, disconnect them. The tilt module must be connected directly to the terminal. After the tilt module has been configured, these additional devices must be reconnected.
 2. Measure the distance between the GPS receiver and the ground surface.
 3. Switch on the terminal.
 4. Switch to the tilt module configuration screen:



⇒ The following screen appears:

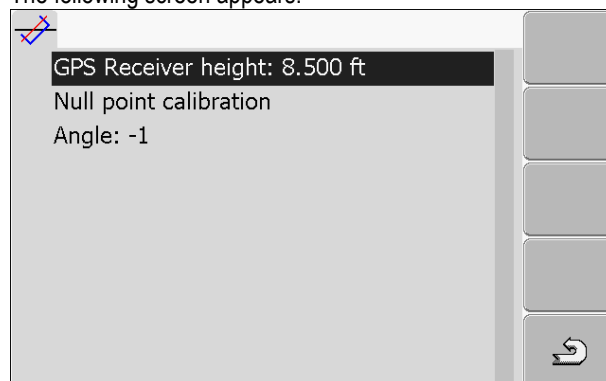

5. Enter the distance between the GPS receiver and the ground surface in the line "GPS receiver height".

6. Position the tractor on a ground surface that is known to be level.
7. Click on the line "Null point calibration".
 - ⇒ The position of the tilt module on level ground is being calibrated.
 - ⇒ After calibration, the angle 0 will appear on the "Angle" line. The displayed angle will change with any tilt of the tractor.
8. Reconnect all of the additional devices that you had disconnected for the configuration.

7.7

Activating an external lightbar

If you connected an external ME Lightbar to the terminal, you must activate it.

To activate the external lightbar, you must first activate its driver.

You can order the external lightbar from Müller-Elektronik with the following item number: 30302490.



Procedure

1. Switch to the "Driver" screen:

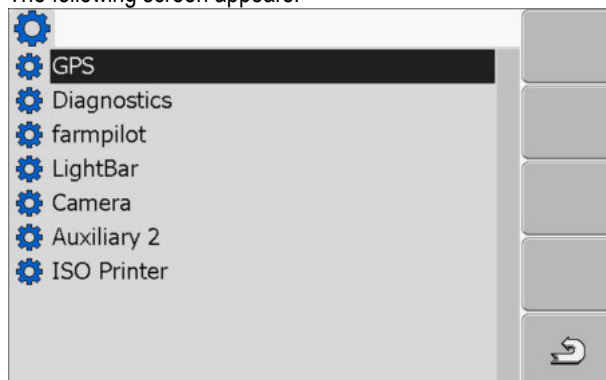

⇒ The following screen appears:



2. Click on "Lightbar".
 - ⇒ The installed drivers appear.
3. Click on the "Lightbar" driver.
 - ⇒ The following icon appears next to the driver 
4.  - Restart the terminal.
 - ⇒ You have activated the external lightbar.

7.8

Camera

7.8.1

Activating a camera

In order to activate a camera, you must activate its driver.

Procedure

1. Switch to the "Driver" screen:



⇒ The following screen appears:



2. Click on "Camera".

3. Click on the "Camera" driver.

⇒ The following icon appears next to the driver 

4.  - Restart the terminal.

⇒ The following function icon appears in the start screen of the "Service" application:



5. You have activated the camera driver.

7.8.2



Operating the camera





The camera serves **solely** for observing the implement functions in non-safety-related working areas of the agricultural implement.

In certain situations, the camera image may appear on the screen with a delay. The delay depends on the respective use of the terminal and can also be affected by external factors and devices.

	! WARNING
	<p>Accident due to delayed image transmission Rapidly moving objects may be detected too late.</p> <ul style="list-style-type: none"> ◦ Do not use the camera as an aid for steering the vehicle. ◦ Do not use the camera in road traffic. ◦ Do not use the camera when driving into intersections. ◦ Do not use the camera as a rear view camera. ◦ Do not use the camera as a visual aid for controlling the implement, especially when a delayed reaction can lead to risks.

Controls

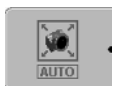
Function icon	Meaning
	Switch between several cameras.
	Rotating the image.

Function icon	Meaning
	Zooming in for camera images.
	Zooming out for camera images.
	Activating automatic camera mode. In automatic mode the camera images will be automatically displayed if a sensor sends a signal to do so. This only works if the vehicle is equipped with a suitable sensor.
	Saving camera settings.
	Leaving the camera.

You can press the function keys even if the camera is set to full screen mode.

Procedure

- You have connected and activated the camera.

1. Switch to the "Camera" screen:



⇒ The following screen appears:



2. Use the function keys to control the camera.

7.9

Configuring the joystick button allocations

The terminal offers you the possibility of assigning the functions of an ISOBUS job computer to the buttons of the joystick. To do so, the ISOBUS job computer and the joystick must fulfil the Auxiliary 2 specification requirements from the ISOBUS standard.



Selecting the function

①	Area with available functions	④	Cursor
②	Icon for the ISOBUS job computer	⑤	Button assignment area
③	Icon for the function		

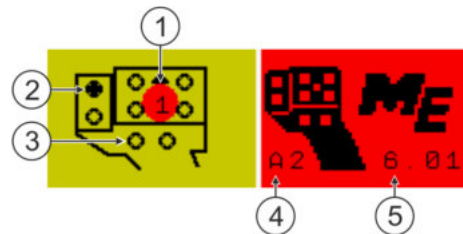

Button assignment. Using the example of the Müller-Elektronik joystick

①	LED colour (position of the side-switch on the joystick)	④	Joystick version
②	Button to which a function is assigned	⑤	Joystick software version
③	Other buttons		

Function icon	Meaning
	Version information
	Deletes all assignments
	Deletes the marked assignment
	Confirms all assignments

Procedure

To activate the driver for this function:

1. Switch to the "Driver" screen:
 | **Service | Driver**
2. Activate the value "Auxiliary2" in driver "Auxiliary 2".
3. - Restart the terminal.

Procedure

To configure the button assignment:

- The joystick and ISOBUS job computer are connected and support the “Auxiliary 2” protocol.
- You have activated the driver “Auxiliary2”

1. To switch to the joystick's configuration screen:

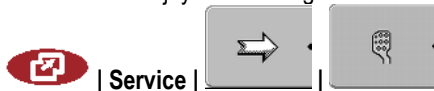

⇒ The following screen appears:

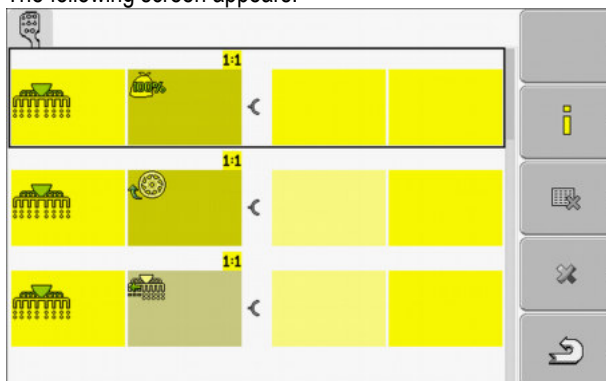

⇒ The icons which appear here will be dependent on the software of the connected ISOBUS job computer. This is only an example.

2.  - Select the function which you wish to assign to a button.

⇒ The following screen appears:

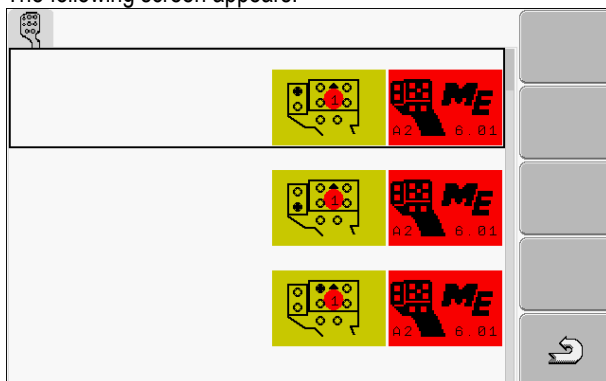

⇒ The content of the screen will depend on the software of the connected joystick.

3. Select the button to which you want to assign the selected function. This is only an example.

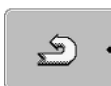

4.  - Exit the screen.

5.  - Restart the terminal.

- ⇒ After restarting, a screen with an overview of the assignments appears.
- ⇒ If this screen does not appear, open the Service application.

6. Confirm the notification “Scroll to the end.”

7. Scroll with the knob all the way to the bottom of the list.

⇒ The following icon appears in green on the right-hand side:





8. - Confirm the assignments. You must re-confirm the assignments after each restart.
 ⇒ You have completed the assignments and can now operate the machine with the joystick.

7.10 Adjusting the brightness for day or night mode

In this chapter you will learn how to adjust the brightness of the display for day or night mode.

Procedure

1. Open the "Service" application:



| Service

⇒ The following screen will appear:

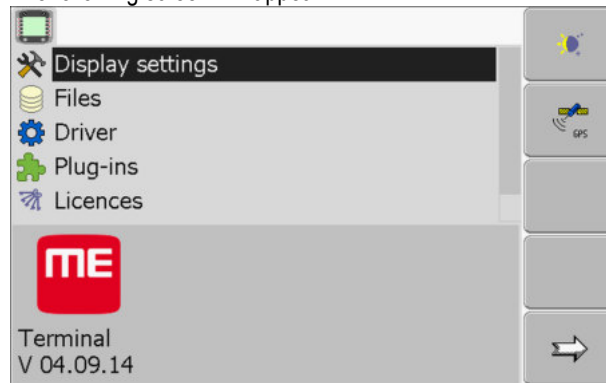

2. Change the operating mode.

Depending on which operating mode is currently active, you can use one of the function icons:



– Activate day mode.



– Activate night mode.

⇒ The brightness of the display will be adjusted immediately.

7.11 Activating and deactivating applications

In the "Service" application you can activate and deactivate other applications that are installed on the terminal.

The applications are installed in packages, in so-called plug ins. A plug in can contain several applications.

You can for example deactivate a plugin if you do not want to use it. The plug-in will then not be displayed in the selection menu.

Name of the plug-in	Includes the following applications
Serial Interface	Serial interface for the transfer of data to the on-board integrated display/controller.
File Server	File Server
Tractor-ECU	Tractor-ECU
ISOBUS-TC	ISOBUS-TC

Name of the plug-in	Includes the following applications
TRACK-Leader	TRACK-Leader SECTION-Control TRACK-Leader TOP VARIABLE RATE-Control
FIELD-Nav	FIELD-Nav

Procedure

To activate and deactivate plug-ins:

1. Switch to the "Plug-ins" screen:



Service | Plug-ins

⇒ The following screen appears:

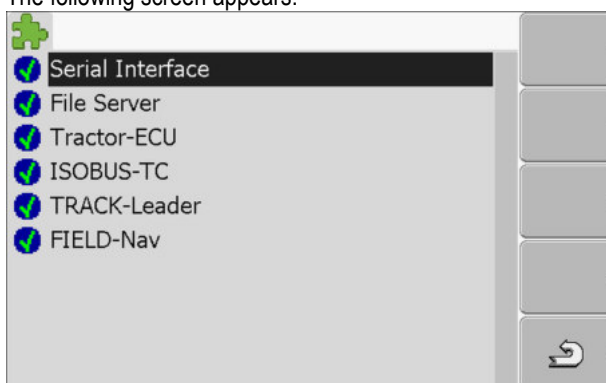

2. - Click on the desired plug-in.

⇒ The symbol next to the name of the plug-in indicates whether the plug-in is activated or deactivated.

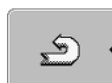

3. - Exit the screen.

⇒ The following message appears:
"Restart the terminal."



4. - Confirm.



5. - Restart the terminal.

⇒ All activated plug-ins appear in the selection menu.

7.12

Activating licenses for full versions of the software

Several applications are pre-installed on the terminal, which you can use for trial purposes for up to 50 hours. After this time has elapsed, they will be automatically deactivated. The amount of free usage time remaining is shown in brackets next to the name of the application.

This menu is not available on terminals running hardware version 1.4.1. The licenses are activated in the TRACK-Leader application, in the "Information" menu.

To activate a license you will require an activation number, which you will receive on purchasing an application from Müller-Elektronik. If you request the activation number by phone or by email, you will be required to give our staff the following information:

- Code – Found under the name of the application on the "License management" screen.
- Serial number of the terminal – Found on the nameplate on the reverse of the terminal.
- Item number of the terminal – Found on the nameplate on the reverse of the terminal.

Procedure

The activation number is entered as follows:

1. Switch to the "Licenses" screen:



Service | Licenses

⇒ The following screen will appear:



2. Click on the desired application.

⇒ The following screen will appear:

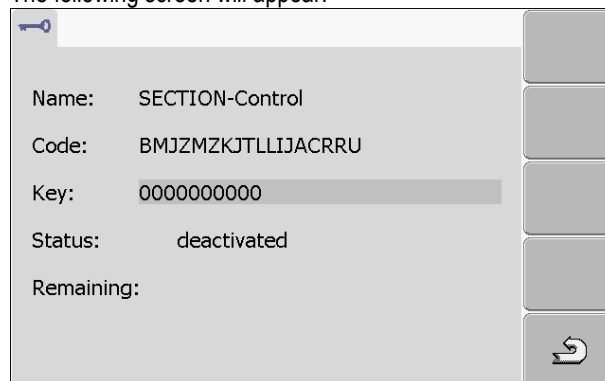

3. Enter the activation number in the "Key" field. You will receive the activation number on purchasing a software license.
4. Confirm

⇒ The following icon will appear next to the application on the "Licenses" screen:



⇒ The application is activated. You can use the application without any restrictions.

7.13

Setting the purpose of the terminal

If you use more than one terminal, you can decide how you want to use this terminal.

The following options are available to you:

- "Login as ISOBUS-UT"
Activate this parameter if you want the ISOBUS job computer to be displayed on the terminal. This parameter must be activated in most instances. On very few self-propelled agricultural machines, the parameter must be deactivated.
- "Run as auxiliary terminal"
The ISOBUS job computer does not log into terminals which log in as "auxiliary terminal".

Procedure

1. Switch to the "Display configuration" screen:



| Service | Display configuration

2. Configure parameter.

7.14

Deleting files from the USB memory device

NOTICE

Potential loss of data!

Deleted files cannot be retrieved!

- Think very carefully about which file you wish to delete.

On the "Files" screen you can delete files from the USB memory device.

The "File" screen only displays files that are stored in either of the following two folders on the USB memory device:

- Screencopy – contains all screenshots you have created
- Taskdata – contains all task data for the "ISOBUS-TC" application

Procedure

1. Switch to the "Files" screen:



| Service | Files

⇒ The following screen appears:

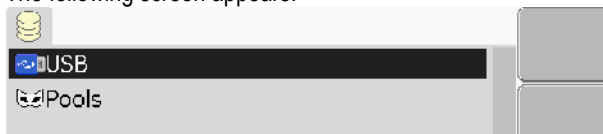

2. Click on "USB".

⇒ The "Screencopy" and "Taskdata" folders will appear.

⇒ If these folders fail to appear, it is because you did not create them on the USB memory device.

3. Click on the desired folder.

⇒ The contents of the folder will be displayed.

A folder may either contain files or further folders.

If nothing is displayed, the folder is empty.

4. Select the files to be deleted.



5. - Delete file (red)

⇒ Deleting file.

7.15

Deleting pools

You can delete the pools to speed up the terminal's operation.

Pools are the intermediate storage for the terminal. Pools are used to temporarily store graphics or text. Over time, the pools will become too large and slow down the operation of the terminal.

When to delete?

- After updating the software of a connected jobcomputer.
- If the terminal operates more slowly than usual.
- When asked to do so by Customer Services.

Procedure

1. Switch to the "Files" screen:



| Service | Files

⇒ The following screen will appear:



2. Click on "Pools".

⇒ The names of several folders will appear.
 ⇒ If the pool is empty, nothing will appear.

3. Click on the desired folder.

⇒ The contents of the folder will be displayed.

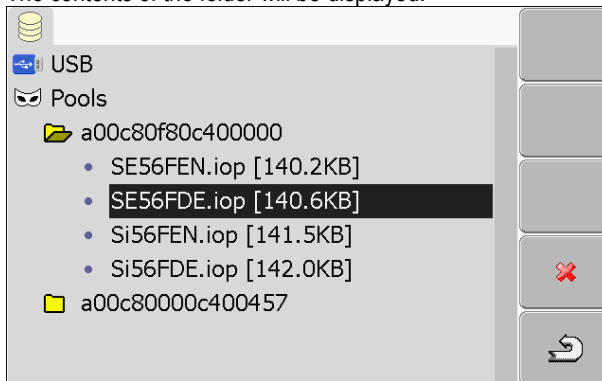

The names of the folders are the ISO IDs of the applications whose temporary data they store.

4. Select the desired file.



5. - Delete file.

⇒ Deleting file.

6. - Restart terminal.

7.16

Activating the "Diagnostics" function

To activate the "Diagnostics" function, you must first activate its driver.

Procedure



1. Switch to the "Driver" screen:

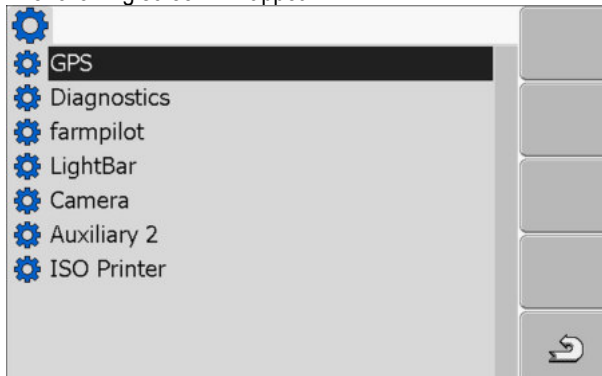

| Service | Driver

⇒ The following screen will appear:

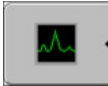

2. Click on "Diagnostics".
3. Click on the "DiagnosticsServices" driver.
 - ⇒ Next to the driver the icon  will appear.
4.  - Restart terminal.
 - ⇒ The following function icon will appear on the start screen of the "Service" application:

 - ⇒ You have activated the "Diagnostics" function.

7.16.1

Diagnostics

The screen "Diagnostics" contains a variety of information that is primarily important to Customer Services. Customer Services can use this screen to determine which versions of the hardware and software are installed on your terminal. This will speed up the diagnostic process if errors arise.

7.17

Screenshots

A screenshot is a photo of the screen being displayed.

If an error occurs when you are using the terminal, Customer Services may ask you to capture a screenshot.

A screenshot can be:

- emailed to Customer Services. Email address: service@mueller-elektronik.de
- sent to the farmplot portal (provided you have activated the farmplot portal)

7.17.1

Configuring the screenshots function

Procedure

- You have activated the "Diagnostics" function. [→ 46]

1. Start the "Service" application:

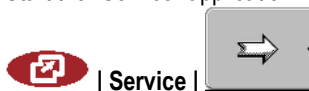

2.  - Open the Diagnostics screen

3. Click on "Screenshot settings".

4. Click on "Activate screenshots".

⇒ The status of the function is displayed on the icon:



- Function enabled



- Function disabled.

5. Click on "Storage location".

⇒ The line will be highlighted with a frame.

6. Select "USB" to save screenshots on the USB memory device.



7. Select "Portal" to send screenshots to the farmplot portal.

7.17.2

Creating screenshots

Procedure

- ☑ You have configured the "Screenshots" function.
 - ☑ If you want to save the screenshots to the USB memory device, you will already have inserted the USB memory device into the terminal.
1. Open any screen.
 2. Press the following buttons in the order displayed and keep them pressed for a short while:

 (on older terminals you need to press the buttons in reversed order)
 - ⇒ While the screen shot is being captured, the icon of a photo camera will be displayed in the center of the display:

 - ⇒ When the camera icon disappears, the screenshot has been created.
 - ⇒ You will find the screenshot you captured in the location you specified as the "Storage location". The USB memory device saves the screenshots in the folder "ScreenCopy".

7.18

CAN-Trace settings

CAN-Trace is a function that logs the data exchange between the terminal and the connected jobcomputers. Customer Services can use the logged data for diagnostic purposes should any errors arise in the system.

If an error occurs when using the terminal, Customer Services may ask you to activate the CAN-Trace function.

Only activate this function if prompted to do so by Customer Services.

Procedure

1. Switch to the "CAN-Trace settings" screen:



1. Click on "Duration (min.)".
2. Set the duration. Specify for how long communication should be logged after the terminal has been restarted. Communication can be logged for a duration of one to five minutes.
3. Click on "Storage location".
4. Select the storage location.
5. Select "USB" to save data on the USB memory device. The USB memory device must be inserted in the terminal.
6. Select "Portal" to send data to the farmipilot portal. farmipilot must be activated before data can be transferred.
7. Click on "Activate CAN-Trace".
 - ⇒ The status of the function is displayed on the icon.
 - ⇒ The icon  must appear next to "Activate CAN-Trace".

8.  - Restart terminal.
⇒ After restarting the terminal, CAN-Trace will log the communication between the terminal and the jobcomputer.
9. Leave the terminal switched on until the set CAN-Trace duration has elapsed.
⇒ The CAN-Trace function will be deactivated automatically.
10. If you specified USB as the storage location, verify that the file "StartupTrace.txt" exists on the USB memory device:

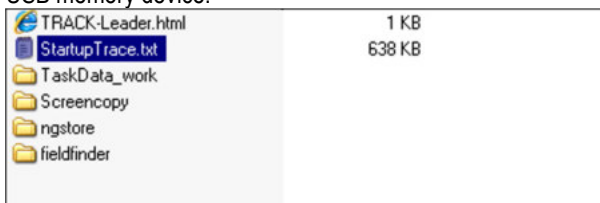

11. If this file is missing, you must run the CAN-Trace function again.
12. Email the "StartupTrace.txt" file to Customer Services. If you chose "Portal" as the storage location, this file will have been sent automatically.

7.19

Activating ISO Printer

In order to activate the ISO printer, you must activate its driver.

Procedure



1. Switch to the "Driver" screen:

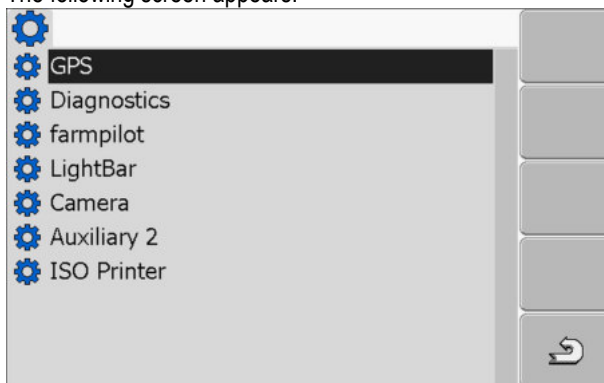

Service | Driver

⇒ The following screen appears:



2. Click on "ISO Printer".
⇒ The installed drivers appear.
3. Click on the "ISO Printer" driver.
⇒ The following icon appears next to the driver 
4.  - Restart the terminal.

8 Tractor-ECU application

The Tractor-ECU application is used to compile all of the information of the vehicle on which the terminal is mounted. Tractor-ECU can transfer this information to other apps (e.g. the position of the GPS receiver to TRACK-Leader or SECTION-Control) or to a connected ISOBUS job computer (GPS signal as a speed source).

The Tractor-ECU application allows you to:

- Create a profile for each vehicle, with specific settings.
- Input the sensors which are mounted on the vehicle.
- Enter the position of the GPS receiver.

If you are using a self-propelled machine, you can simply enter the position of the GPS receiver. [→ 57]

After launching the Tractor-ECU application, the following screen appears:

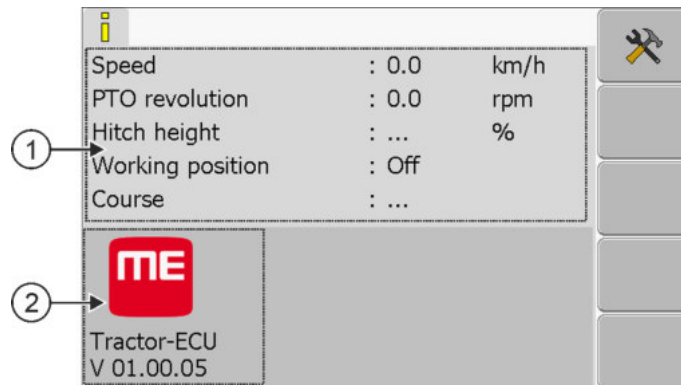

Tractor-ECU application start screen

<p>① Main section Displays the current parameters.</p>	<p>② Version number Name of the application and version of the installed software</p>
---	--

If the value “...” appears for a parameter on the screen, the relevant sensor is not connected.

Function icon	Meaning
	<p>Calling up a list of vehicles</p>



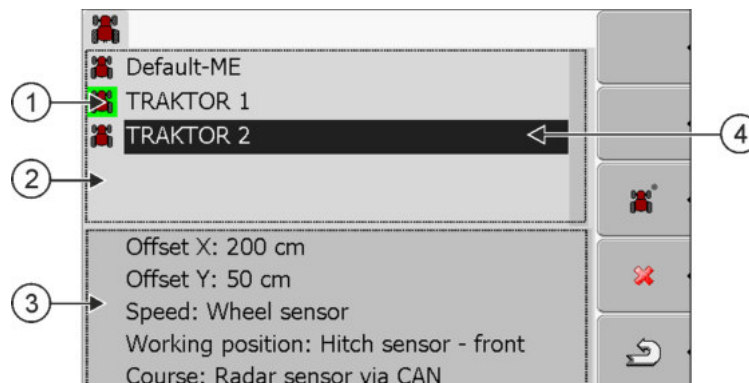

8.1

Add a vehicle profile



List of vehicle profiles

①	Activated vehicle profile (the icon is marked in green)	③	Information on the marked vehicle profile
②	List of all available vehicle profiles	④	Cursor

Function icon	Meaning
	Add a vehicle profile
	Vehicle profile cannot be deleted
	Delete the vehicle profile
	Return

Procedure

1. Call up the Tractor-ECU application:



2.  - Call up the list of vehicles.

3.  - Add a new vehicle profile.

⇒ A new vehicle profile appears on the screen.

⇒ You can now configure the parameters of the new vehicle profile.



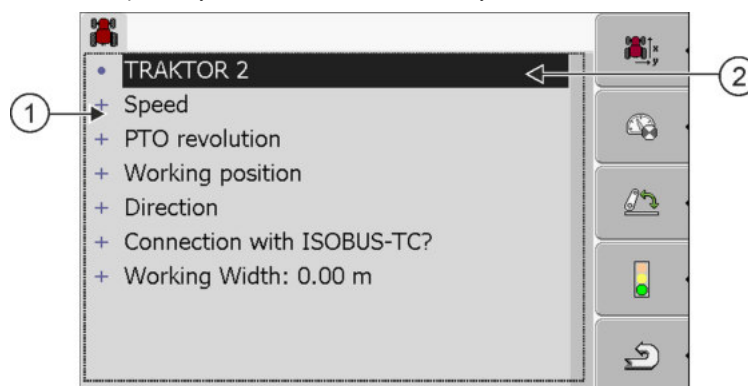

8.2

Configuring the parameters for a vehicle profile

In a vehicle profile, you can set the sensors that you want to use.

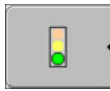

①	List of parameters	②	Cursor
---	--------------------	---	--------

Function icon	Meaning	Only appears if...
	Switch to the "Settings" screen Input the position of the GPS receiver [→ 57].	
	Activate the vehicle profile	The selected vehicle profile is not activated.
	Return	
	Calibrating the speed sensor	A wheel sensor or radar sensor is used for speed measurements. The sensor is connected to the terminal.
	Calibrate the working position sensor	A hitch sensor - front or a hitch sensor - rear is used to measure the working position. The sensor is connected to the terminal.

Procedure

1. Call up the Tractor-ECU application:



| Tractor-ECU

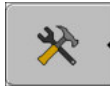

2. - Call up the list of vehicles.

3. Select the vehicle profile.

4. Modify the required parameters. You can also change the name of the vehicle profile.

Parameters in a vehicle profile

Only those parameters which you can use to configure the hardware version of your terminal are shown.

When configuring sensors, you will need not only to select which sensor is mounted, but also how this sensor is connected to the terminal.

This can be done in two ways:

- A sensor is connected to the terminal via the serial interface (**port B**). (e.g.: Operating position sensor, all sensors which can be connected via the 7-pin signal socket). The parameters for the sensors connected in this way do not have the suffix "via CAN".
- A sensor is connected to the ISOBUS and its signal reaches the terminal via the CAN interface (**port A**). The parameters for such sensors always have a "via CAN" suffix.

Speed

Configuring the speed sensor. This measures the speed.

Possible values:

- "disabled"

- No sensor measures the speed.
- "Wheel sensor"
A wheel sensor is connected to the terminal. The wheel sensor must be calibrated [→ 55].
- "Radar sensor"
A radar sensor is connected to the terminal. The radar sensor must be calibrated [→ 55].
- "GPS receiver"
The speed is calculated using GPS.
- "Unknown sensor via CAN"
A wheel sensor or a radar sensor is connected to the terminal via CAN.
- "Radar sensor via CAN"
A radar sensor is connected to the terminal via CAN.
- "Wheel sensor via CAN"
A wheel sensor is connected to the terminal via CAN.

PTO revolution

Configuring the PTO (power take-off) revolution sensor. This measures the PTO revolutions.

Possible values:

- "disabled"
No sensor measures the PTO revolutions.
- "Revol. sensor - front"
A revolution sensor which is fitted onto the front PTO.
- "Revol. sensor - rear"
A revolution sensor which is fitted onto the rear PTO.
- "Impulses/rev."
Number of impulses which the PTO transfers per revolution.

Work position

With this parameter, you can set whether there is a work position sensor and how its signal reaches the terminal.

Possible values:

- "deactivated"
No sensor measuring the work position.
- "Front via connector B"
A work position sensor, is located on the front hitch or on the implement mounted on the front hitch. It is connected to the terminal via connector B. The work position sensor must be configured [→ 55].
- "Rear via connector B"
A work position sensor, is located on the rear hitch or on the implement mounted on the front hitch. It is connected to the terminal via connector B. The work position sensor must be configured [→ 55].
- "Unknown sensor via CAN"
There is a work position sensor determining the work position of the implement. It is connected to an ISOBUS job computer or to a different terminal. The signal reaches the terminal via CAN.
- "Front via CAN"
There is a work position sensor determining the work position of the implement at the front of the vehicle. It is connected to an ISOBUS job computer or to a different terminal. The signal reaches the terminal via CAN.
- "Rear via CAN"

There is a work position sensor determining the work position of the implement at the rear of the vehicle. It is connected to an ISOBUS job computer or to a different terminal. The signal reaches the terminal via CAN.

Direction

You can use these parameters to configure whether the terminal can receive a direction signal, and the source from which it originates. When a direction signal is present, the TRACK-Leader application can correctly mark the vehicle movement when travelling in reverse.

Possible values:

- "deactivated"
No direction sensor is connected to the terminal. If another ISOBUS device transmits a direction signal, however, this is not blocked.
- "Unknown sensor via CAN"
The terminal is receiving a direction signal via CAN whose source is unknown.
- "Radar sensor via CAN"
A radar sensor with direction identification is connected to the terminal via CAN.
- "Wheel sensor via CAN"
A wheel sensor with direction identification is connected to the terminal via CAN.
- "Direction sensor"
A direction sensor is connected to the serial interface of the terminal. Does not function if a working position sensor is connected to the terminal.
- "inversion"
This parameter inverts the meaning of the signals. Only for use with the "Direction sensor" parameter.

Connection with ISOBUS-TC?

With this parameter, you can set whether the Tractor ECU application should communicate with the ISOBUS-TC application. In doing so, it transmits: Counters, work position, position of the GPS receiver.

Deactivate this parameter only if the terminal is used as a secondary terminal and the GPS receiver is connected to a different terminal.

Working width

This value is transmitted to the ISOBUS-TC application to calculate the processed area.

This parameter primarily enables you to document processed areas for non-ISOBUS implements if you are working in TRACK-Leader without an ISOBUS job computer, and if you also use the ISOBUS-TC App simultaneously with ISO-XML tasks.

In this case, no implement data is normally transmitted to ISOBUS-TC. To enable calculation of the processed areas in the Farm Management Information System at a later time, you can enter the working width here.

You can only then use this function if you also have an operating position sensor.

Remember to select a different vehicle profile in the tractor ECU after working with a non-ISOBUS implement, to not always to transfer the working width.

8.2.1 Calibrating the speed sensor

When calibrating the speed sensor using the 328.085ft (100m) method, determine the number of targets which the speed sensor encounters over a distance of 328.085ft (100m).

If you know the number of targets for the speed sensor, you can also input this manually.

Procedure

- You have measured and marked a distance of 100m. The distance must correspond to the field conditions. You must therefore drive across a meadow or a field.
- The vehicle with the connected implement is operational for a 100m drive and is at the start of the marked distance.
- You have connected a wheel sensor or radar sensor to the terminal.
- You have selected the value "Wheel sensor" or "Radar sensor" in the "Speed" parameter.

1. Call up the Tractor-ECU application:



2.  - Calling up a list of vehicles.

3. Select the vehicle profile.

4.  - Press.

⇒ The following screen appears:

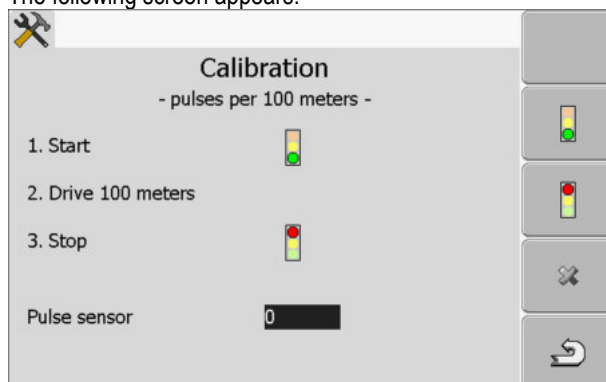

5. When determining using the 100m method: Follow the sequence of actions on the terminal.
OR

For manual input:  - Enter the value.

6.  - Return to the vehicle profile.

⇒ You have calibrated the speed sensor.

8.2.2 Configuring a working position sensor

If a work position sensor is connected to the terminal via connector B, you must tell the terminal the principle according to which the sensor functions.

During the configuration, you can choose between three types of sensor:

- "analog"

You are using an analog work position sensor, which measures the height of the hitch linkage as a percentage.

- "digital"

You are using a digital, ISO-compatible work position sensor in accordance with ISO 11786. The sensor is connected to the terminal via the signal socket.

- "ME-sensor Y"

You are using a work position sensor provided by Müller-Elektronik. The sensor is connected to the terminal.

Procedure

- You have connected a working position sensor directly to the terminal or via the signal socket to the terminal.
- You have selected the value "Hitch sensor - front" or "Hitch sensor - rear" in the "Working position" parameter.

1. Call up the Tractor-ECU application:



2.  - Call up the list of vehicles.

3. Select the vehicle profile.

4.  - Press.

⇒ The following screen will appear:

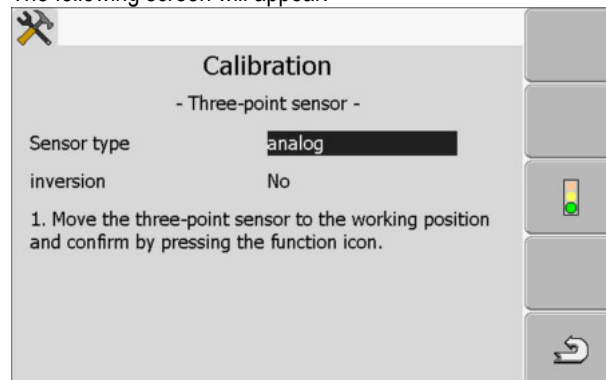

5. Select a sensor type.
6. Select whether you want to invert the signal. Inversion only makes sense when you have selected "digital" or "ME-sensor Y".

7. If you have selected "digital" or "ME-sensor Y":  - Return to the vehicle profile.

OR

If you have selected "analog": Move the hitch to the height at which the working position starts.

8.  Press to confirm.

9.  - Return to the vehicle profile.

⇒ You have configured the working position sensor.

8.2.3 Entering the position of the GPS Receiver

When you have mounted and connected the GPS receiver, you must enter its exact position.

In order to enter an accurate position for the GPS receiver, you must measure the distances of the GPS receiver from the longitudinal axis and from the so-called attachment point [→ 58].

When entering distances, please note that it is essential to specify whether the GPS receiver is to the left or right of the tractor's longitudinal axis and whether it is positioned before or after the attachment point.

What is the position of the GPS receiver?	The distance should be entered as follows
to the right of the longitudinal axis	y
to the left of the longitudinal axis	- y
before the attachment point	x
after the attachment point	- x

Procedure

1. Call up the Tractor-ECU application:



2. - Call up the list of vehicles.

3. Select the vehicle profile.



4. - Press.

⇒ The following screen will appear:

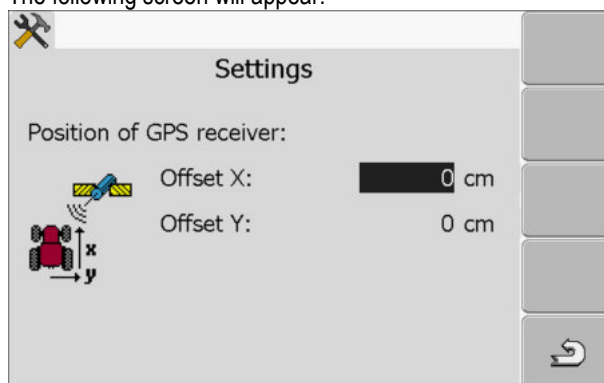

5. Measuring the position of the GPS receiver. You will find out how to do this in the following subchapters.
6. Input the measured distances in the "Offset X" and "Offset Y" fields.



7. - Return to the vehicle profile.

⇒ You have input the position of the GPS receiver for the selected vehicle profile.

For machines fitted with an ISOBUS job computer

On the following illustration distances are marked, which must be measured for each different machine.

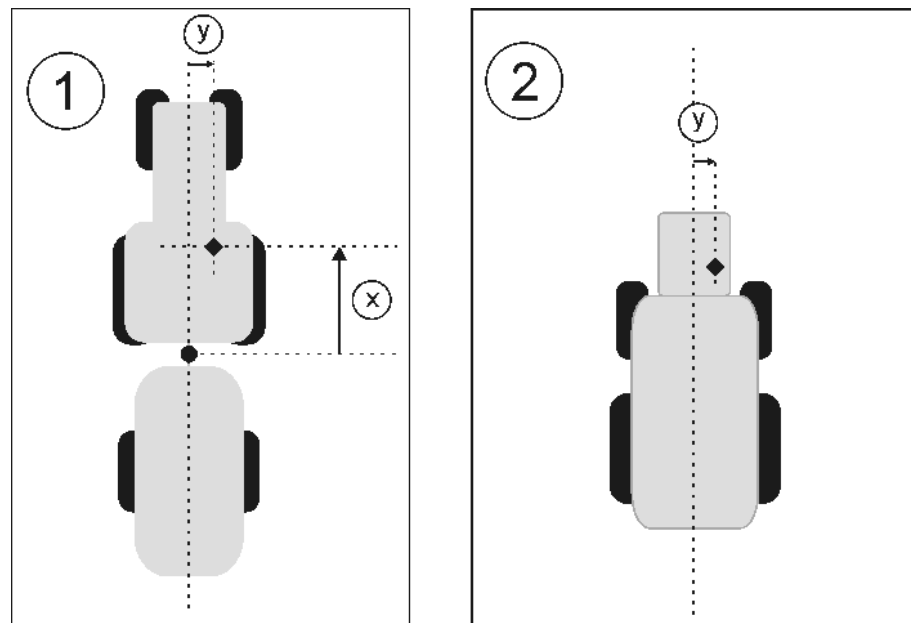

GPS receiver for ISOBUS machines

●	Attachment point for mounted or trailed implements	◆	GPS receiver
①	Mounted or trailed implements	②	Self-propelled machines
y	Distance between the longitudinal axis and the GPS receiver for Offset Y	x	Distance for Offset X

Procedure

To determine the distances for tractors with an ISOBUS-job computer:

- The jobcomputer of the farm equipment in use is connected to the terminal
 - In the jobcomputer the geometry of the farm equipment is configured.
1. Measure the distance between the attachment point of the attached or trailed implement and the GPS receiver.
 2. Input the measured distance as parameter "Offset X".
 3. Measure the distance between the longitudinal axis of the machine and the GPS receiver.
 4. Input the measured distance as parameter "Offset Y".

Procedure

To determine the distances for self-propelled machines with an ISOBUS job computer:

- The jobcomputer of the farm equipment in use is connected to the terminal
 - In the jobcomputer the geometry of the farm equipment is configured.
1. Input 0 inch as parameter "Offset X".
 2. Measure the distance between the longitudinal axis of the machine and the GPS receiver.
 3. Input the measured distance as parameter "Offset Y".

8.3 Activating vehicle profiles

In order to work with the inserted parameters, you must activate the vehicle profile of the used vehicle.

Procedure

1. Call up the Tractor-ECU application.



2.  - Call up the list of vehicles.

3. Select the vehicle profile.

4.  - Activate the vehicle profile.

9 ISOBUS-TC task processing

9.1 Using ISOBUS-TC

The ISOBUS-TC application is an application from Mueller-Electronics which establishes an interface between the ISOBUS job computer, the TRACK-Leader application and the FMIS (Farm Management Information System) on the ISOBUS terminal.

With ISOBUS-TC, you can:

- Plan and edit ISO-XML tasks on the terminal,
- Edit ISO-XML tasks which you have planned on the PC using your FMIS.

All information contained in the order will be transferred by ISOBUS-TC to specialized applications of the terminal. This means that each application is doing exactly what it can do best:

- The position of the field is transferred to FIELD-Nav. It can therefore navigate the vehicle directly to the field.
- The field boundaries, guidance lines, prescription maps and other information about processed fields stored in the task are transferred to TRACK-Leader. The field can be therefore processed.
- The target rates are transferred from a prescription map to the ISOBUS job computer. In this way, you do not have to worry about inputting the target rates.
- ISOBUS-TC documents work duration, and the persons, implements and resources involved.

9.2 Adjusting how you use ISOBUS-TC

First of all, you must decide how you will use the ISOBUS-TC application. The operation of ISOBUS-TC and TRACK-Leader is dependent on this setting.

There are two scenarios in which you can use ISOBUS-TC. Use the "Work with ISO-XML?" parameter to set the scenario you will work with:

- "Yes"

Select this setting if you set up tasks on your PC or if you want to set up tasks on the terminal. In this instance, you must always start a task before you start work. Only then does the data exchange between ISOBUS-TC, TRACK-Leader and the ISOBUS-job computer function. You will need a "ISOBUS-TC" license for this.
- "No"

Select this setting if you do not use tasks. Instead, you use application maps in shp format or enter the application rates directly into the ISOBUS-job computer. In this instance, ISOBUS-TC only works in the background. You will not need a license for this. You can also skip the other sections of the instructions regarding ISOBUS-TC.

Procedure

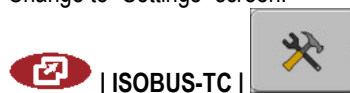

You can change the mode of the "ISOBUS-TC" application as follows:

1. Change to "Settings" screen:

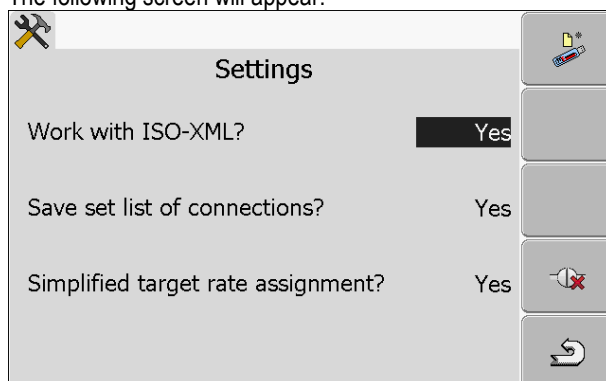

⇒ The following screen will appear:



2.  - Select and click on the "Work with ISO-XML?" line.
⇒ The mode will change with each click.
3. Set the desired mode.
4.  - Restart the terminal.
⇒ The set mode will be activated after restart.

9.3

Configuring the list of connections

The list of connections indicates the ISOBUS job computers from which the terminal will load the geometries of the connected implements. This geometry is required in order to calculate the position of all implement components on the basis of the GPS signal. Only in this way are precise parallel guidance and section control possible.

Procedure

If you are using the ISOBUS-TC application, you can configure the list of connections as follows:

In simple systems, the terminal can set up the list of connections automatically. In particular, when the ME terminal is the only unit which contains the tractor geometry (see: Entering the position of the GPS Receiver [→ 57])

It can however still be necessary to set the list of connection manually in the following instances:

- If a tractor job computer (Tractor-ECU), in which the tractor geometry is saved, is mounted as an independent job computer on the tractor. In this instance, you must decide which Tractor-ECU is connected in the list of connections with other equipment: the application on the ME terminal or on the tractor job computer.
- If the system cannot organize the ISOBUS job computer by itself. For example when more than one implement is connected to the tractor (e.g.: slurry tanker and planter/seedler).
- When the connection to an ISOBUS job computer is interrupted during the start-up of a ISO-XML task. In most cases, the list of connections will be set correctly as soon as you reconnect the ISOBUS job computer.
- If this error message appears when starting the terminal: "List of connection is incomplete."
- When the following error message appears when starting a navigation in TRACK-Leader: "The device data is still loading." The settings in the list of connections can eliminate this problem.

10 Serial Interface application

The "Serial Interface" application is used to enable communication between the terminal and a non-ISOBUS compatible on-board integrated display/controller.

This interface enables you to use all of the applications together with the GPS signal and the on-board integrated display/controllers, in order to:

- Transfer target rates (using the LH-5000 protocol or the ASD protocol); [→ 62]
- Switch sections on and off (using the ASD protocol). [→ 63]

So that you do not need to reconfigure the application each time, you can create an individual profile for each on-board integrated display/controller.

10.1 Transfer target rates via LH5000

Tested on-board integrated display/controllers*

Manufacturer	On-board display/controller	Software version	Baud rate
RAUCH	Quantron A	V1.20.00	9600
RAUCH	Quantron E	V3.51.00	9600
RAUCH	Quantron E2	V2.10.00	9600
RAUCH	Quantron S	V3.90.00	9600
RAUCH	Quantron S2	V1.00.05	9600
ME	Spraylight	V02.00.10	9600

* - Only on-board integrated display/controllers are listed for which we were able to determine that the serial interface was functional. Results may differ with different software versions.

Procedure

- You have checked whether you need to activate the LH5000 protocol on the on-board integrated display/controller. If yes, you have activated the protocol.

1. Connect the on-board integrated display/controller to the terminal. [→ 14]

2.  - Switch on the terminal.

3. Open the Serial Interface application:

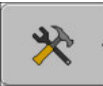

4.  - Open the list of implement profiles.

5.  - Add a new implement profile.
⇒ A new implement profile appears on the screen.

6. Configure the parameters as shown in the following steps.

7. "Operating Mode" -> "Target Rate Transfer"

8. "Protocol" -> "LH5000"

9. "Implement type" -> Select the implement with which you are working.
10. "Baud rate" -> normally "9600". The baud rate is dependent on the on-board integrated display/controller.

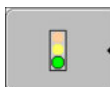

11. - Activate the implement profile.

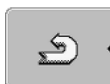

12. - Press and confirm to save the implement profile.

13.  - Restart terminal.

Further steps

You have set up the serial interface. You must now configure the applications of the terminal.

In the TRACK-Leader application:

1. Deactivate the "SECTION-Control" parameter under "Settings / General".
2. Create an ag equipment profile for the combination of your tractor and mounted implement.
3. Load a prescription map.

You can load the prescription map in two ways:

- As a shp file, in the TRACK-Leader application.
- As part of a ISO-XML task, if you are using the ISOBUS-TC application and a FMIS.

For more information, please refer to the TRACK-Leader and ISOBUS-TC operating instructions.

10.2 Switching sections and transferring target rates via ASD

Tested on-board integrated display/controllers*

Manufacturer	On-board display/controller	Software version	Baud rate	Target rate transmission	Section control
Amazone	Amatron3	V1.09.00	19200	+	-
Amazone	Amatron+	V3.23.00	19200	+	-
RAUCH	Quantron A	V1.20.00	19200**	-	+
RAUCH	Quantron E	V3.51.00	19200**	+	+
RAUCH	Quantron E2	V2.10.00	19200**	+	+
Müller-Elektronik	Spraylight	V02.00.13	19200	+	+
Müller-Elektronik	DRILL-Control	-	19200	+	+

* - Only on-board integrated display/controllers are listed for which we were able to determine that the serial interface was functional. Results may differ with different software versions.

** - "GPS Control" must be activated on the on-board integrated display/controller

You can use the ASD protocol to transfer target rates to a prescription map or to switch sections. The degree to which you can use these functions will depend on the on-board integrated display/controller.

In order to be able to perform transfers using the ASD protocol, you will need to activate the "ASD-Protocol" license.

Procedure

To configure the serial interface in order to switch sections using your on-board integrated display/controller:

You have activated the "SECTION-Control" parameter in the "General" menu of the TRACK-Leader application.

You have checked whether you need to activate the ASD protocol on the on-board integrated display/controller. If yes, you have activated the protocol.

1. Connect the on-board integrated display/controller to the terminal. [→ 14]

2.  - Switch on the terminal.

3. Call up the SerialInterface application:

 | SerialInterf

4.  - Open the list of implement profiles.

5.  - Add a new implement profile.
 ⇨ A new implement profile appears on the screen.

6. Configure the parameters as shown in the following steps.

7. "Operating Mode" - "Section switching"

8. "Protocol" - "ASD"

9. "Implement type" - Select the implement with which you are working.

10. "Tractor<-->Working point" - Here, enter the distance between the suspension point of the tractor and the working point.

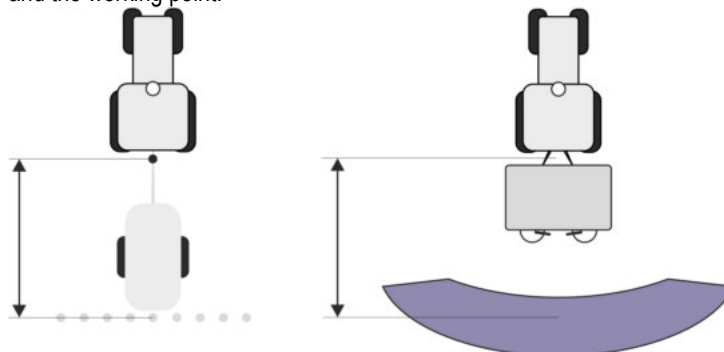



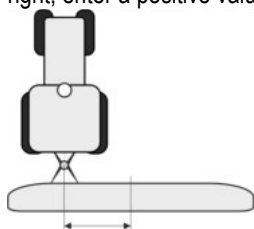

11. "Offset L/R" - This parameter is used to set the geometry of asymmetrical implements. Here, input the distance by which the middle of the working width should be shifted. For a shift to the

right, enter a positive value, and for a shift to the left, enter a negative value.



- 12. "Working Width" - The working width set in the on-board integrated display/controller.
- 13. "No. of sections" - The number of sections set in the on-board integrated display/controller.

- 14.  - The width of the individual sections set in the on-board integrated display/controller.
- 15.  - Back.
- 16.  - Activate the implement profile.
- 17.  - Press and confirm to save the implement profile.
- 18.  - Restart terminal.

Further steps

You have set up the serial interface. You must now configure the applications of the terminal.

In the TRACK-Leader application:

1. Activate the "SECTION-Control" parameter under "Settings / General".
2. Configure the section switching in "Settings/ SECTION-Control".
3. Load a prescription map.

You can load the prescription map in two ways:

- As a shp file, in the TRACK-Leader application.
- As part of a ISO-XML task, if you are using the ISOBUS-TC application and a FMIS.

For more information, please refer to the TRACK-Leader and ISOBUS-TC operating instructions.

11 FILE-Server application

The FILE-Server application is used to define a save location on the terminal. This save location can be used by all ISOBUS implements which do not have their own USB interface. This enables the updating of certain ISOBUS job computers, and also the possibility of saving, for example protocols or error messages.

A "Fileserver" folder is created for this purpose on the hard disk of the terminal. All ISOBUS implements can access this folder, and write or read data there.

The folder has a maximum disk space of 5 MB.

Procedure

- If you want to copy files to the terminal, these must be on your USB memory device, in the "Fileserver" folder.

1. Call up the FILE-Server application:



| File-Server

⇒ The application start screen appears.



2. - Press.



3. - Copy files from the USB memory device to the terminal (Import).



4. - Copy files from the terminal to the USB memory device (Export).

⇒ One of the following messages appears: "Start import?" or "Start export?".

5. Click "Yes" to confirm.

⇒ The data will be copied.

⇒ A report appears.

6. Confirm using "OK".

⇒ You have successfully imported or exported the data.

12 Maintenance and servicing

NOTICE

This product does not contain any components which require maintenance or repair!
Never unscrew the casing!

12.1 Servicing and cleaning the terminal

- Press the keys with your fingertips. Avoid using your finger nails.
- Only clean the product with a soft, damp cloth.
- Only use clear water or glass cleaner.

12.2 Disposing of the unit



When it has reached the end of its service life, please dispose of this product as electronic scrap in accordance with applicable EU legislation.

12.3 Instructions on retrofitting

Instructions on how to retrofit electrical and electronic farm equipment and/or components

Agricultural equipment used today features electronic components and parts whose function can be affected by other farm equipment which emits electromagnetic waves. Such effects could lead to personnel being put in danger, if the following safety instructions are not adhered to.

Selecting components

When selecting components, make sure first of all that the retrofitted electrical and electronic components comply with the current version of the EMC Directive 2004/108/EC and carry the CE marking.

User responsibility

When retrofitting a machine with electrical and electronic farm equipment and/or components connected to the vehicle's electrical system, it is your own responsibility to check whether the installation causes interference with the vehicle's electronic system or other components. This applies, in particular, to the electronic control of:

- electronic hitch control (EHR),
- Front lifting gear,
- PTO shafts,
- Motor,
- Gear.

Additional requirements

The following requirements must be met in order to retrofit mobile communication systems (e.g. radio, phone):

- Only approved devices complying to national regulations (e.g. BZT approval in Germany) are to be installed;
- The equipment must be installed as a fixed installation.
- The use of portable or mobile devices inside the vehicle is permissible only via a connection to the permanently installed outside antenna;
- The transmitting part must be spatially separated from the vehicle's electronic system.

- When attaching the antenna, pay attention to proper installation, including a sound ground connection between the antenna and the vehicle's ground wire.

For information on wiring and installation as well as the maximum allowable current consumption, please also refer to the installation guide provided by the machine manufacturer.

12.4

Checking the software version

Procedure

1. Open the "Service" application:



2. The following screen will appear:

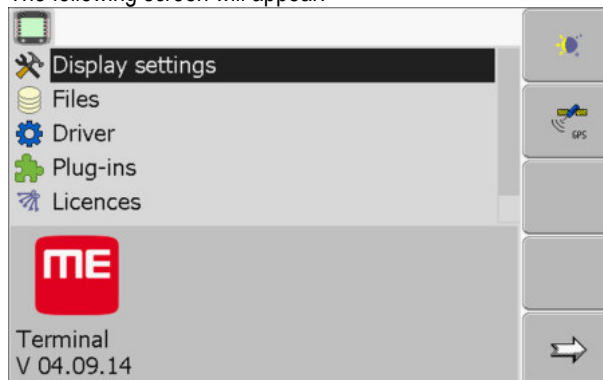

3. The software version can be found below the ME logo.

12.5

Technical specifications

12.5.1

Technical specifications of the terminal

Parameters	Value	
Operating voltage	10 - 30 V	
Operating temperature	-20 - +70 °C	
Storage temperature	-30 - +80 °C	
Weight	1.3 kg	
Dimensions (W x H x D)	220 x 210 x 95 mm	
Protection class	IP 54 in accordance with DIN 40050/15	
EMC	In accordance with ISO 14982 / PREN 55025	
ESD protection	In accordance with 10605	
Power input	For terminal without GSM modem and without external devices.	Typically: 0.4A at 13.8 V
Display	VGA TFT color display; display size (diagonal): 5.8 inches ; resolution: 640 x 480 pixels	

Parameters	Value
Processor	32-bit ARM920T up to 400 MHz
RAM	64 MB SDRAM
Boot-Flash	128 MB
Internal clock	Buffered by capacitor, keeps the time for 2 weeks without an external power supply.
Keyboard	17 keys plus rotary knob.
Outputs	2 x CAN 1 x USB 1.1 2 x RS232. Second RS232 with restricted functionality. 2 x M12 for two analog cameras (optional)

12.5.2

Pin assignment of port A

Port A is a 9-pin D-sub port of the ISO agricultural machinery interface (CAN).

Pin no.:	Signal:	Pin no.:	Signal
1	CAN_L	6	- Vin ¹ (GND)
2	CAN_L ¹	7	CAN_H ¹
3	CAN_GND ¹	8	CAN_EN_out ²
4	CAN_H	9	+ Vin ¹
5	CAN_EN_in		

Legend:

+Vin = voltage supply (+)

-Vin = ground (-)

¹) - Signals marked with ¹ correspond to the CiA assignment (CAN in automation).

Both signals CAN_L and CAN_L¹ and/or CAN_H and CAN_H¹ are linked internally and used to loop the CAN bus through.

Assigning CAN_EN_in to the supply potential (= +Vin) enables the terminal to be switched on.

The signals '-Vin' and 'CAN_GND' are directly linked with both connectors, therefore it is crucial to avoid differences in potential between the pins of these two connectors.

²) is compliant with TBC_Pwr in ISO 11783. When the terminal is switched on, this pin is under voltage (supply voltage minus approx. 1.2V).

12.5.3

Pin assignment of port B

The pin assignment of port B is dependent on the hardware version of the terminal.

Terminals with hardware versions from 3.0.0

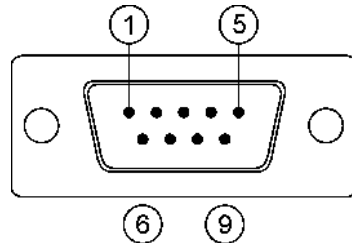

9-pin. D-Sub connector

Port B is a 9-pin D-Sub port.

The connector can be used for the following purposes depending on its assignment:

Purpose	Pins used
As second CAN interface	7, 9
As second serial interface	2, 3, 4, 5
As signal input for two digital and one analog signal.	1, 5, 6, 8

Pin assignment of port B

Pin no.:	Signal:	Pin no.:	Signal
1	Wheel sensor ¹	6	PTO ²
2	/RxD	7	CAN_H
3	/TxD	8	Working position sensor ³ or Reverse signal for determining the driving direction
4	Voltage supply for GPS receiver ⁴	9	CAN_L
5	GND		

Legend:

- 1) Digital input as per: ISO 11786:1995 chapter 5.2
- 2) Digital input as per: ISO 11786:1995 chapter 5.3
- 3) Digital input as per: ISO 11786:1995 chapter 5.5
- 4) The pin is switched in parallel with pin 4 by port C. Total loading is 600mA.

Terminals with hardware versions from 1.4.1

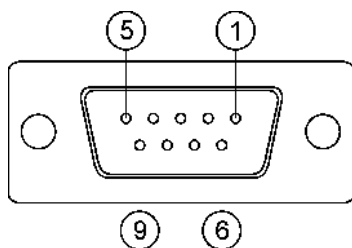

Port B is a 9-pole D-Sub socket.

Pin assignment of port B

Pin no.:	Signal:	Pin no.:	Signal
1	CAN_L	6	-Vin*
2	CAN_L*	7	CAN_H*
3	CAN_GND*	8	CAN_EN_out
4	CAN_H	9	+Vin
5	CAN_EN_in or Operating position sensor		

12.5.4

Pin assignment of port C

Port C is an RS232 interface

	CAUTION
	<p>Damage to the equipment caused by short circuit</p> <p>Pin 4 of port C is live. The voltage depends on the operating voltage of the terminal and is used to supply the DGPS Receiver from Müller Elektronik.</p> <p>Other GPS Receivers may suffer damage if connected to this port.</p> <p>Before connecting a different GPS Receiver:</p> <ul style="list-style-type: none"> ◦ Check what voltage the terminal is connected to (12 V or 24 V). ◦ Check the pin assignment of the GPS Receiver. ◦ Check the allowable voltage for the GPS Receiver. ◦ Compare the terminal voltage to the allowable voltage for the GPS Receiver. ◦ Compare the pin assignment. ◦ Only connect the GPS Receiver to the terminal, if the voltage range and pin assignment of both devices don't differ from each other.

Pin assignment of port C

Pin no.:	Signal
1	DCD
2	/RxD

Pin no.:	Signal
3	/TxD
4	Voltage supply for GPS receiver ¹
5	GND
6	DSR
7	RTS
8	CTS
9	RI (+5 V)

Legend:

¹) The pin is switched in parallel with pin 4 by port B. Total loading is 600mA.

When switched on, the terminal routes current to the farm equipment that is connected via the RS232 connector. The voltage of the RS232 connector is dependent on the operating voltage of the terminal.

When connected to a 12 V battery, the terminal will transfer approx. 11.3 V to the connected equipment.

When connected to a 24 V battery, the terminal will transfer approx. 23.3 V to the connected equipment.

The use of a GPS Receiver only requires the signals RxD and TxD as well as GND.

12.5.5

Pin assignment of camera ports 1 and 2

Ports 1 and 2 are used to connect an analogue camera. The pin assignment is identical for both ports.

Ports 1 and 2 are 5-pin, A-encoded M12 sockets. Please refer to the following table for the pin assignment.

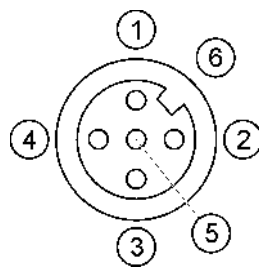

Pin assignment of the socket (in the terminal)

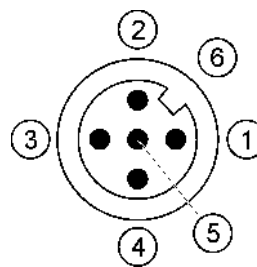

Pin assignment of the connector

Pin	Signal
1	Pin is exclusively intended for use by ME (do not connect anything)
2	GND
3	Pin is exclusively intended for use by ME (do not connect anything)

Pin	Signal
4	Video signal
5	Video screen
Outer sheathing	Screen

13 Notes