

DAMMANN[®]



Pflanzenschutztechnik
Fahrzeugtechnik
Airporttechnik

DAMMANN-trac

DT 2800H S5 EcoDrive™

DT 3500H S5 EcoDrive™

DT 2400H S5 Highlander EcoDrive™



DAMMANN-trac DT 2800H S5 EcoDrive™

Standard equipment at the highest level

- Engine power 210 kW (285 PS)
- Drive with 4 hydraulic wheel motors
- Front axle steering
- Air-suspended chassis (load suspension regulated)

Options:

- Electronically controlled all-wheel steering with trim function of the rear axle
- Fixed axle at 3.00 - 3.30 m
- 2-stage hydraulic track adjustment
- 1.80 - 2.25 m or 2.25 - 3.00 m
- Tire pressure control system
- Central lubrication system

Profi-Class Mounted Sprayer

- Tank volume 5000 - 7000 l
- Fresh water tank 500 l
- Working width 24 - 42 m
- Piston diaphragm pump 320 l/min - 500 l/min

Now with 3,00 or 3,30 m
track available!

	DT 2800H S5
Engine power	210 kW (285 PS)
Engine type	Mercedes Benz OM 936
Drives	4 hydraulic wheel motors
Emmission	EU stage V
Speed	40 km/h (option 50 km/h)
Fuel tank	250 l
Ad Blue tank	25 l
Hydraulic system	LS Hydraulic system with 180 l/min Pump capacity at max. 210 bar
Ground clearance	1100 mm
Length *	8250 - 10600 mm
Width *	2550 - 3000 mm
Height *	3700 - 4000 mm
Permissible total weight	18 t
Tank volume	5000 - 7000 l
Working widths from - to	24 - 42 m
Standard tyres	VF 380/90 R50

* Depending on mounted unit





**DAMMANN-trac DT 3500H S5
EcoDrive™**

Standard equipment at the highest level

- Engine power 230 kW (313 PS)
- Drive with 6 hydraulischen Radmotoren
- Hydraulic suspension
- 1st and 3rd axle steered

Options:

- Tyre pressure control system
- 15 t Trailer hitch with two-circuit brake system
- Centralized lubrication

Profi-Class Mounted Sprayer

- Tank volume 8000 - 12000 l
- Fresh water tank 500 l
- Working width 30 - 42 m
- Piston diaphragm pump 500 l/min

	DT 3500H S5
Engine power	230 kW (313 PS)
Engine type	Mercedes Benz OM 936
Drives	6 hydraulic wheel motors
Emmision	EU stage V
Speed	40 km/h (option 50 km/h)
Fuel tank	380 l
Ad Blue tank	40 l
Hydraulic system	LS Hydraulic system with 205 l/min Pump capacity at max. 210 bar
Ground clearance	1050 mm
Length *	9900 - 11500 mm
Width *	2550 - 3000 mm
Height *	3700 - 4000 mm
Permissible total weight	25 t
Tank volume	8000 - 12000 l
Working widths from - to	30 - 42 m
Standard tyres	520/85 R42

* Depending on mounted unit



Manoeuvrability with three Axes

With its three axes, the *DAMMANN-trac* DT 3500H is very easy to operate and has a turning circle with an inner radius of approx. 6.25 m at a track width of 2.25 m.

1st and 3rd axle track in track.

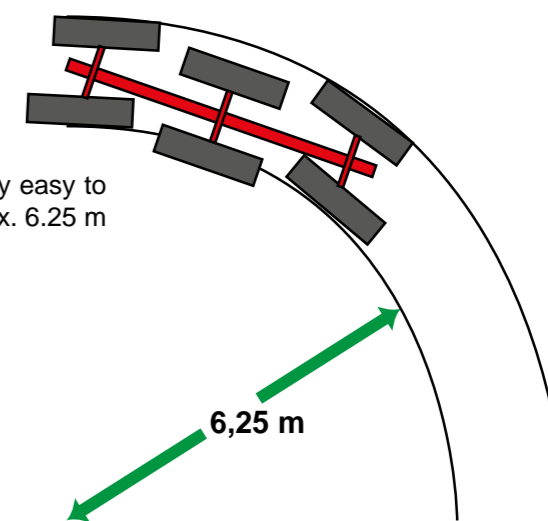

DAMMANN-trac DT 2400H S5 Highlander EcoDrive™

Standard equipment at the highest level

- Engine power 210 kW (285 PS)
- Drive with 4 hydraulic wheel motors
- 2-stage hydraulic track adjustment 2.25 - 3.05 m
- Hydraulic height adjustment 1000 mm - 1800 mm
- Electronically controlled all-wheel steering

Options:

- Straw deflector
- Hill-Control

Profi-Class Mounted Sprayer

- Tank volume 4400 - 5000 l
- Fresh water tank 500 l
- Working width 24 - 36 m
- Piston diaphragm pump 400 l/min

	DT 2400H S5 Highlander
Engine power	210 kW (285 PS)
Engine type	Mercedes Benz OM 936
Drives	4 hydraulic wheel motors
Emmision	EU stage V
Speed	40 km/h (Option 50 km/h)
Fuel tank	250 l
Ad Blue tank	25 l
Hydraulic system	LS Hydraulic system with 180 l/min pump capacity at max. 210 bar
Ground clearance	1150 - 1900 mm
Length *	8100 - 9850 mm
Width *	2700 - 3000 mm
Height *	3750 - 4000 mm
Permissible total weight	18 t
Tank volume	4400 - 5000 l
Working widths from - to	24 - 36 m
Standard tyres	380/90 R46

* Depending on mounted unit



Straw Deflector

(option for DT 2400H Highlander)

- Crop is kept away from the wheels

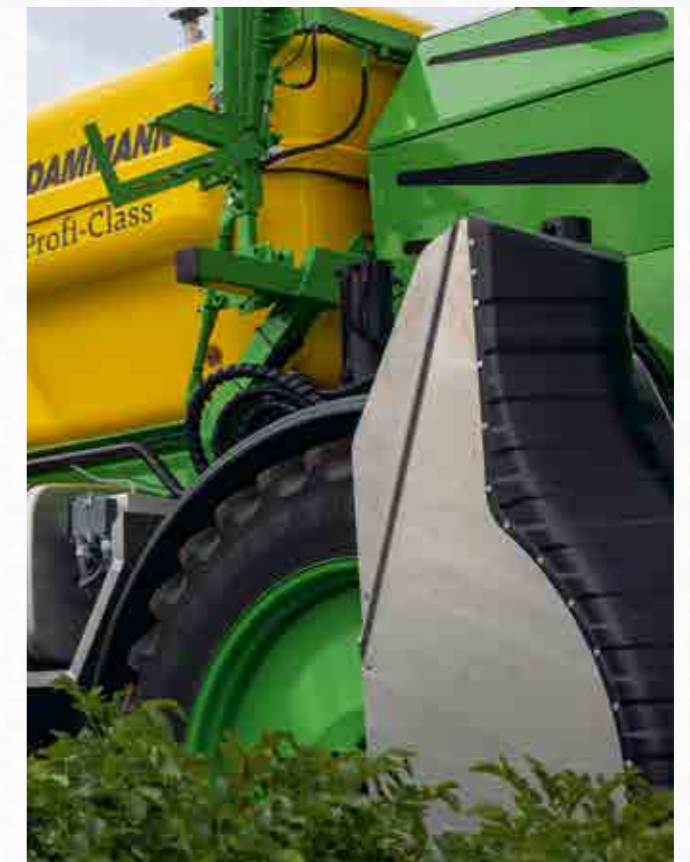

Hill-Control

(option for DT 2400H Highlander)

- Control for driving on slopes
- Vehicle is held in horizontal position
- Centre of gravity always in the middle of the axles
- Wheels are always vertical
- Each leg is individually controlled
- The crop aspiring to the sun will become more spared

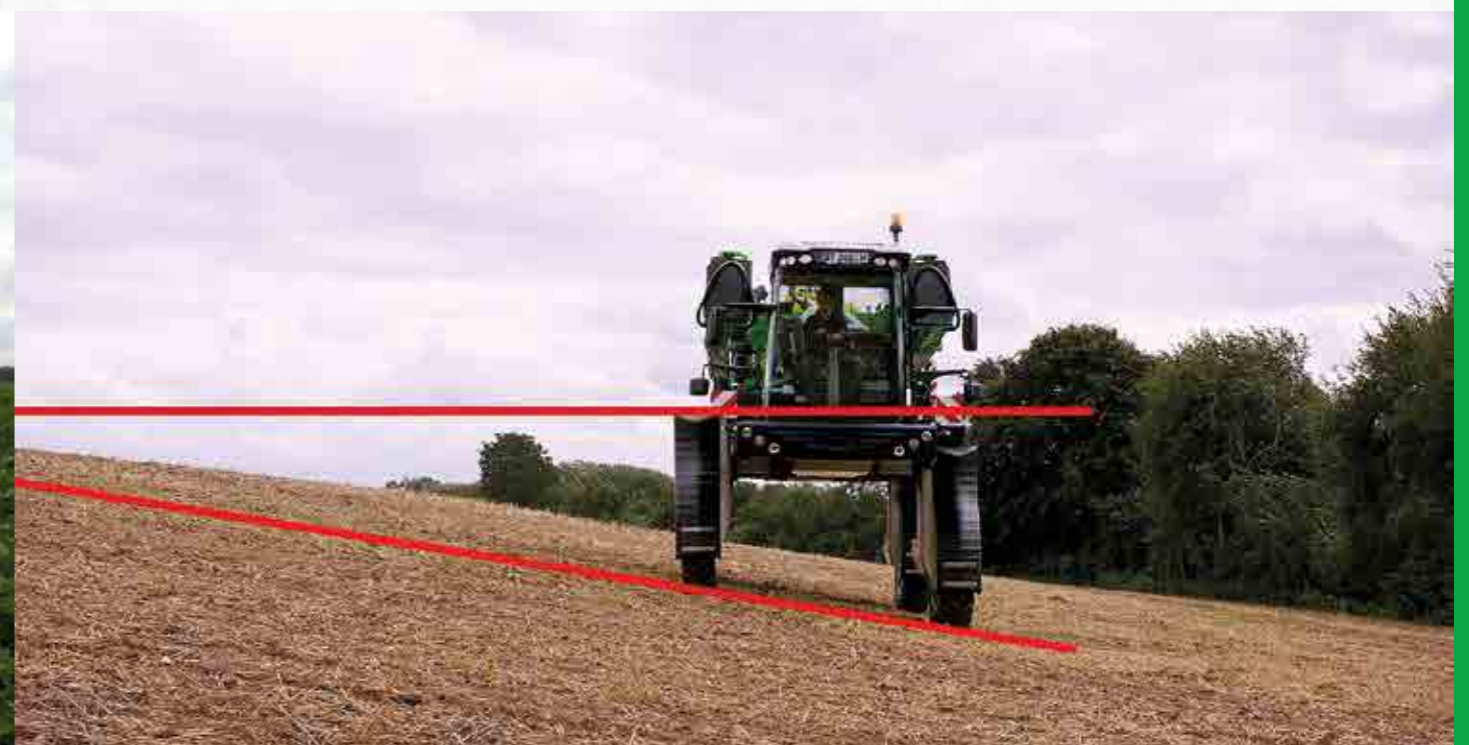
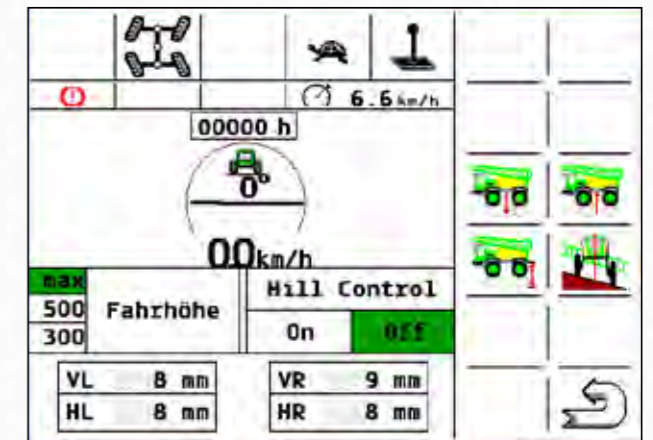



The *DAMMANN-tract* Carrier vehicle for gentle inventory maintenance

Low operating costs through coordinated interaction of efficient and low-maintenance components.

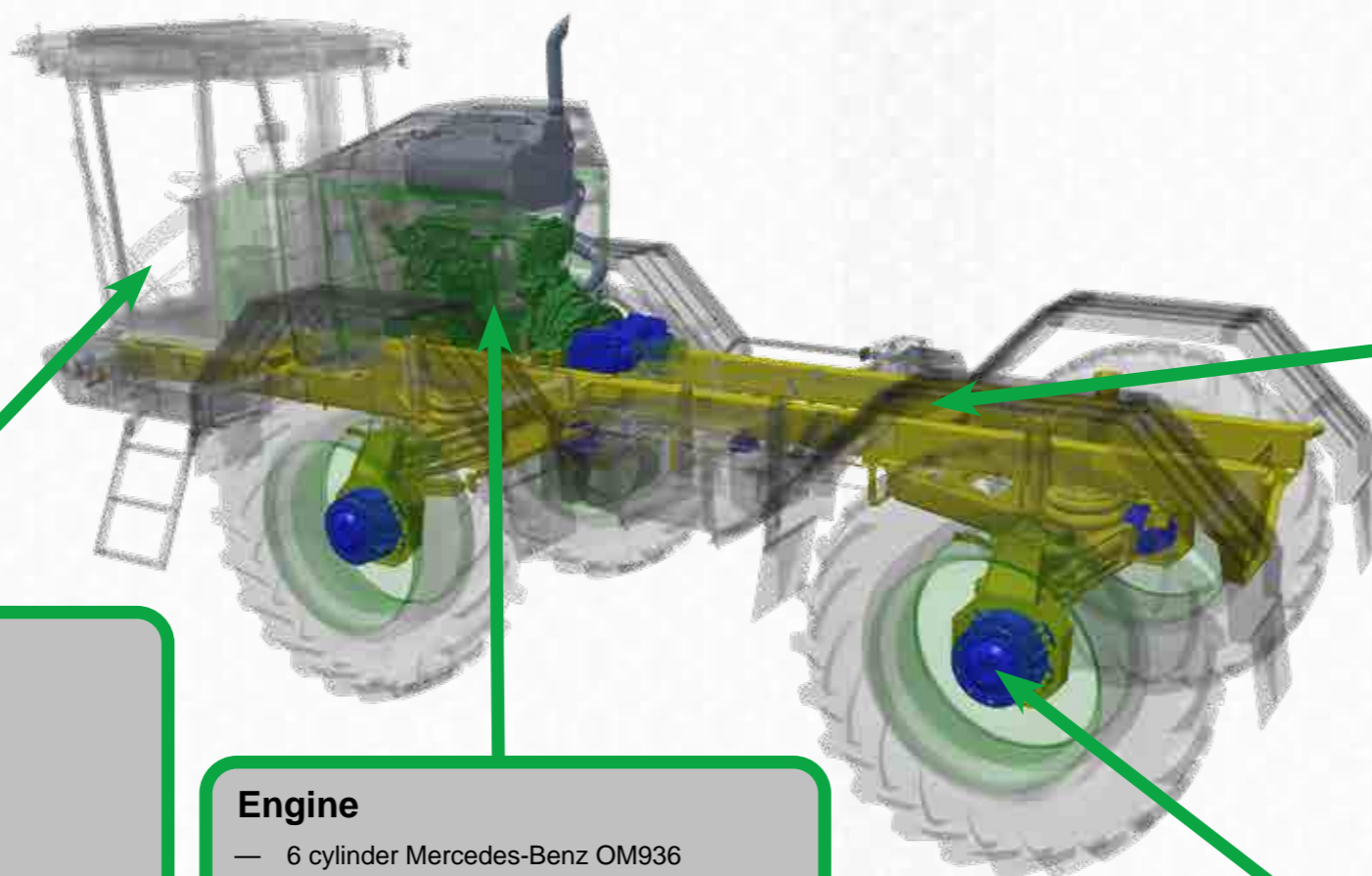

Ride comfort

- Mode selection
 - Accelerator pedal
 - Joystick
- Cruise control for:
 - Road
 - Tramline
 - Headland
- Maximum speed 40 km/h (optional 50 km/h)
- Final speed on the road already at 1200 rpm (1450 rpm at 50 km/h)
- Has a positive effect on the fuel consumption

Engine

- 6 cylinder Mercedes-Benz OM936
- 7,7 l cubic capacity
- Power 285 (DT 2800H + DT 2400H) + 313 PS (DT 3500H)
- Maintenance intervals 750 h
- Latest exhaust technology
 - Catalyst and particulate filter
- Load-dependent motor control

Frame and Chassis

- Carrier vehicle for swap body
 - Crop protection sprayer
 - Fertilizer spreader
- Axles
 - Optimum crop protection due to high ground clearance
 - Clearance within the track
- Tyres
 - Variety of tyre and track width combinations
- All-wheel steering
 - Series for DT 3500H and DT 2400H
 - Optional for DT 2800H
- Track adjustment
 - Optimal adaptation to the cultures
 - Series on the DT 2400H
 - Optional for DT 2800H

Traction Drive

The latest generation brings power to the ground

- Hydraulic wheel motors
 - High gradeability
 - High starting torque
 - Maintenance-free multiple disk brakes
 - Good braking effect
Vehicle comes to a standstill safely
- Intelligent travel drive control EcoDrive™
 - Optimum traction
 - Diesel engine always at the ideal operating point

Cabine

The category 4 cabin of the DAMMANN-trac offers more overview due to larger glass surfaces. The interior was designed for ergonomic operation of all switches and good visibility of the indicator lights.

When designing the interior, great attention was paid to comfort at the workplace. The sprung seat and the adjustable steering column are ergonomically arranged. The most important controls and the drive lever are close together and clearly arranged. They are easy to operate for the driver. The control terminal for the mounted implement, is spring-mounted on the driver's seat, it is positioned without restriction of the view. Drink holders and storage compartments are easily accessible from the driver's seat.

- Good all-round visibility
- Optimum noise insulation
- Sliding door
- Storage compartments
- Protected, easily accessible service box
- Grammer ACTIMO XXL air-suspended driver's seat with headrest
- Armrest right incl. drive lever
- Pre-fitting for camera system
- DAB+ radio with CD drive and Bluetooth connection for telephone
- Emergency seat
- Heat-insulating panes
- Automatic heating and air-conditioning system
- Integrated vehicle display
- LED worklights front and rear
- Pneumatically foldable ladder

Mobile Phone and Tablet Holder

(option)

- Suitable brackets for the **DAMMANN-trac** cabin
- Holder for 10" Tablet
- Holder for 8" Tablet
- Holder for mobile phone



Driver Seat Grammer ACTIMO Evolution

(option)

- Seat heating
- Highest seating comfort
- Armrest left



Possible Equipment

2-Stage Track Adjustment

(Series for DT 2400H / option for DT 2800H)

Track adjustment makes the DAMMANN-trac DT 2800H universal useable in various crops. The driver changes the track width from the cab. Possible track widths are 1.80 - 2.25 m (depending on tyres), 2.25 - 3.00 m and 2.55 - 3.30 m. (All options only in conjunction with all-wheel steering)

3,00 oder 3,30 m Fixed Track

(option for DT 2800H and DT 3500H)

- Adaptation to row and bedding crops
- Suitable for Controlled Traffic Farming (CTF)

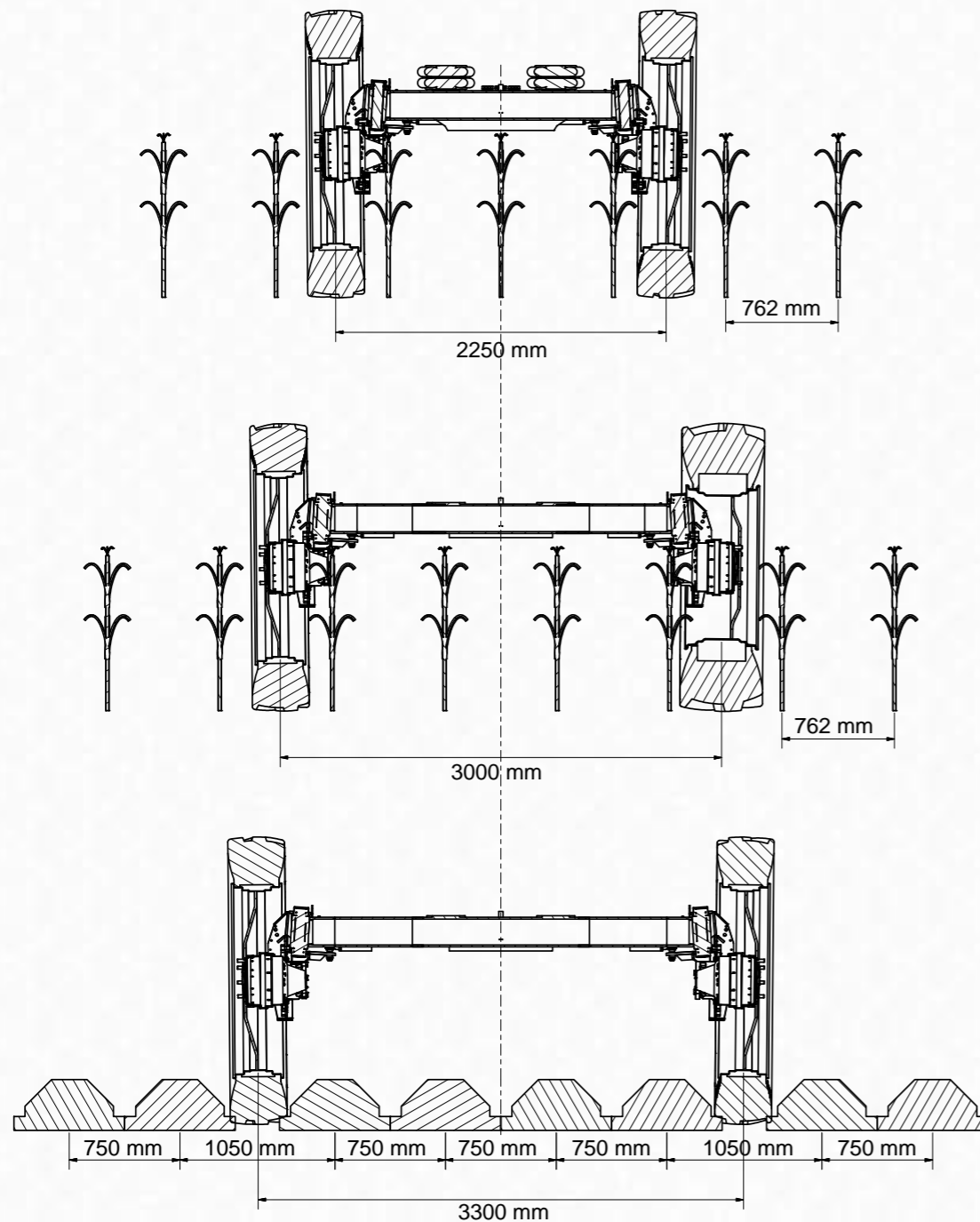

All Wheel Steering

(option for DT 2800H)

The optional all-wheel or four-wheel steering system on the DT 2800H makes the **DAMMANN-trac** even more agile.

Standard version with fixed rear axle

Smaller turning circle and better Tracking accuracy, with additional rear axle steering

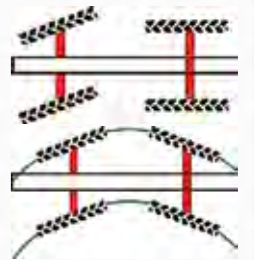

Steering Systems

(option)

- GPS-controlled steering system:
 - Satellite-supported, precise and comfortable driving in the tramlines
- Automatic steering system via optical, ground-guided sensors for row detection
- Convenient activation of the steering function via foot switch
- Pre-fitting of a control valve for automatic steering systems:
 - Retrofitting of a steering system is possible without any problems
- Third party GPS steering system and GPS receiver possible:
 - Installation of a GPS steering system or GPS receiver supplied by the customer
 - Advantage for companies with their own RTK station or RTK signal license fee

Camera Systems

(option)

- Rear view control with one camera:
 - Rear view camera with view behind the vehicle
- Tramline control with one camera:
 - Tramline camera under the vehicle with a view of the wheel into the tramline
- Reversing control + tramline control with two cameras:
 - Automatic, direction-controlled switching of the view when driving forwards or backwards in the display
 - Change of view possible manually at any time
- Display options:
 - On separate monitor
 - Connection of the system to the ISOBUS terminal MC1, HD 8 pad or HD 12 pad
- Additional LED illumination for the camera field of view possible



View behind the vehicle



View into the Fahrgasse

Tire Pressure Control System

(option for DT 2800H and DT 3500H)

- Ideal rolling resistance on the road to save fuel and minimise tyre wear
- Optimum ground pressure in the field
- Control via the ISOBUS terminal
- Optional automatic level-controlled adjustment of the internal tyre pressure by ATC
- Optional additional compressor for fast filling

Maintenance Made Easy with a Central Lubrication Bar

(option)

- Each axle is centrally greased via a lubrication bar
- Easy to reach

Central Lubrication System

(option)

- While the machine is running, the central lubrication system supplies each lubrication point with the necessary grease.
- Absolutely reliable, electronically precisely controlled and precise dosed
- Each bearing and bushing of the axles receives the amount of lubricant it really needs
- No annoying downtimes
- Increases operational readiness and reliability
- Reduces maintenance costs
- Monitoring of flow rate, pressure and grease level
- Automates maintenance
- Operation integrated in the vehicle display
- In addition, the central lubrication system can be fitted to the lifting mast, the boom and all parts of the sprayer
 - Lubrication of the lifting mast
 - Lubrication of the boom



Trailer Hitch

(option for DT 2800H and DT 3500H)

- Trailer hitch up to 15 t
- Dual line brake system
- 7-pole. electrical connection
- Ideal for carrying a water wagon



Profi-Class Mounted Sprayer

- Sturdy base frame with directly supported tank for a low centre of gravity. For the DT 3500H on a three-point pendulum frame
- Frame with ball socket holder for changing devices
- GFK safety tank from 4400 to 12000 l with additional safety volume and surge walls for a safe transport, 2 filling openings with ventilation compensation, integrated fresh water tank, hydraulic agitators and cleaning nozzles
- Digital level indicator *EasyControl*
- DAMMANN professional boom:
 - Hydraulic folding and height control
 - Spring-loaded boom suspension
 - Integrated link chain in the lifting mast for gentle cable routing
 - Sturdy sprayer boom with protected nozzle carriers
 - Integrated collision protection
 - 50% aluminium for greater stability and weight reduction
 - Horizontal and vertical damping of the boom
 - Electropneumatic slope compensation via double cylinder
- 1/2" stainless steel nozzle pipe with 50 cm nozzle carrier spacing and pressure circulation flushing with automatic switchover
- Tandem nozzle carrier with electropneumatic nozzle switch-off, including one set of injector nozzles POM
- Robust and durable piston diaphragm pump
- Electric 4-way suction valve
- Electric 4-way program valve in pressure range
- Large suction and pressure filter with automatic, pneumatic switch-off of the pressure filter flushing
- Electropneumatic equal pressure control
- ISOBUS control via BASIC terminal, joystick III and ECU III Maxi
- 15 l hand washing container
- Injector for increasing the suction power during filling
- Remote-controlled 60 l swivel and illuminated flush centre with ring flush, push nozzles, Canister cleaning nozzle
- Electro-pneumatic pressure line emptying
- Comfort package (protective gloves, soap dispenser and air pistol)



DAMMANN-trac Mounted Sprayer - Overview

Mounted Sprayer for:	DT 2800H	DT 3500H	DT 2400H
Tank volume	-	-	4400 l
	5000 l	-	5000 l
	6000 l	-	
	7000 l	-	
	-	8000 l	
	-	10000 l	
Fresh water tank		500 l	
Boom width	24 m	-	24 m
	27 m	-	27 m
	28 m	-	28 m
		30 m	
		33 m	
		36 m	
	39 m*	39 m	
	42 m*	42 m	
Pump performance	320 l/min - 500 l/min	500 l/min	400 l/min

*Not at 7000 l

ISOBUS-System

- Individual adaptation options for almost every function of the crop protection sprayer
- Volume measurement via flow meter and pressure sensor
- Pressure control of the constant-pressure diaphragm
- Control of hydraulic functions
- Level measurement (*EasyControl*)
- Circulation control
- Integrated counter
- Operation via:
 - Joystick
 - S-Box
- ISOBUS terminal
- Automatic boom control (option)



ISOBUS-TC — TASK-Controller for ISOBUS Processing

(option for BASIC terminal und *HD 8 pad*)

- Convenient documentation
- Simple planning of applications
- Data exchange to the Farm Management Information System
 - About ISO-XML
 - Shape format
- Imports and exports finished documentation for the Farm Management Information System (FMIS)



Overviel Terminal

	BASIC Terminal	MC 1	<i>HD 8 pad</i>	<i>HD 12 pad</i>
	1	2	3	4
Standard as of classic	standard	option	option	option
Screen	5,7"	10,4"	8"	12,1"
Operation by	button	button	touch	touch
GSM Modem*	-	option	option	option
Connector of cameras	-	option	yes	yes
USB connector	yes	yes	yes	yes
Update with APPS	yes	yes	yes	yes

* SIM card not included

The DAMMANN terminals comply with the ISO 11783 standard and are AEF-certified. Please refer to the AEF database for the current status of certified functionalities.



1



2



3



4



5

1 BASIC -Terminal

2 MC 1-Terminal

3 *HD 8 pad*

4 *HD 12 pad*

5 Joystick

TRACK-Leader Parallel Driving System

(option)

- Exact driving of parallel tracks
 - In A/B, A+, headland or contour mode
- Mark obstacles and save field data such as boundaries
- Interrupted operations can be saved and continued at any time
- On-screen-lightbar
- HEADLAND-Management® included



SECTION-Control

(option)

- GPS-controlled switching on and off of boom sections or individual nozzles
- Advantages:
 - Fewer overlaps
 - Work even at night or in poor visibility
 - Savings in resources
- Can also be used for other devices

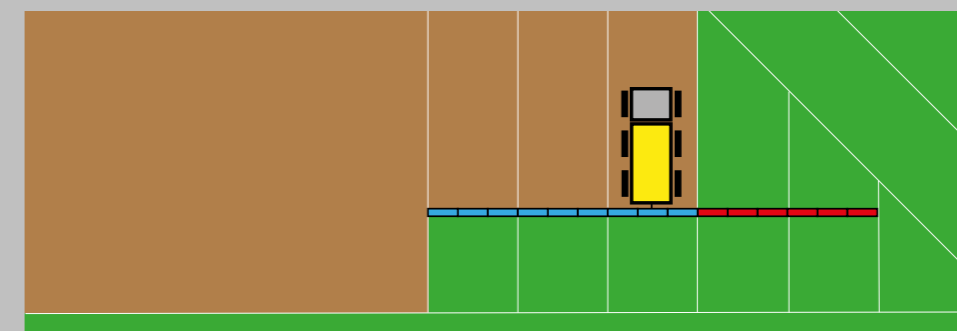

GPS Receiver

(option)

- Correction signals EGNOS, WAAS, GLONASS, GLIDE or RTK
- Deviations between 2 - 25 cm (depending on GPS receiver)



Weather Station

(option)

- Recording by ISOBUS
- Display of data on ISOBUS terminal:
 - Air temperature
 - Wind direction
 - Air pressure
 - Relative humidity
 - Longitudinal inclination
 - cross slope
 - Apparent and actual wind speed



DAMMANN Fluid Indicator

(option)

Display of pH value and temperature

- Measurement of the pH value and the temperature in the barrel sump
- Indication in the display
- The user can influence the pH value of chemical mixture during the induction process

Influence of the pH value on pesticides

- Greater effect of the plant protection product in the case of an ideal pH value
- Reduction of saponification
- Resistances are avoided by optimal pH-value

The water temperature also plays a role

- Better solubility in warm water, especially with salty components in the PSM

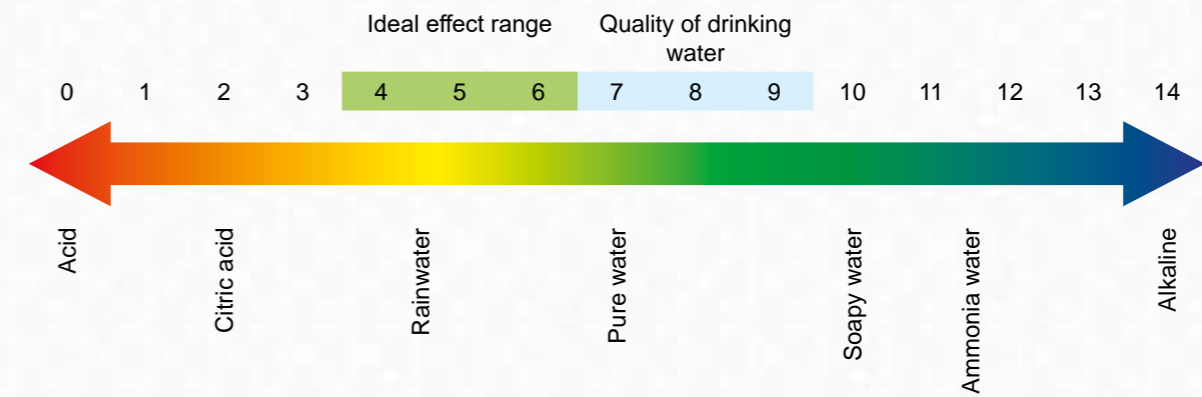







Nozzles and Nozzle Switches

Nozzle carrier and nozzle tube

- Standard electropneumatic tandem nozzle carrier
- 1/2" stainless steel nozzle tube
 - 1" stainless steel nozzle tube (option)
- Pressure circulation flushing
 - Immediate availability of spray liquid at the nozzle carriers
 - Prevents an uneven start of the nozzles (butterfly effect)
- Individual adjustment of 5 - 14 boom sections according to customer requirements (for partial EDS up to 18 boom sections)
- Further nozzle carriers are available as an option:
 - Single nozzle carrier
 - Triple nozzle carrier
 - Quattro nozzle holder with multifunction switch

Nozzle Control

(option)

	Vario-Select Automatic multifunction circuit
	MultiSelect Management of two nozzle sets in one nozzle line
	EDS (TB-EDS-pro) Single nozzle control
	T-S-D Partial surface-specific nozzle switching for surface treatment according to application chart with different spray rates within one working width
	S-D-S Sensor nozzle control
	C ~ C ~ A® Curves ~ Control ~ Application

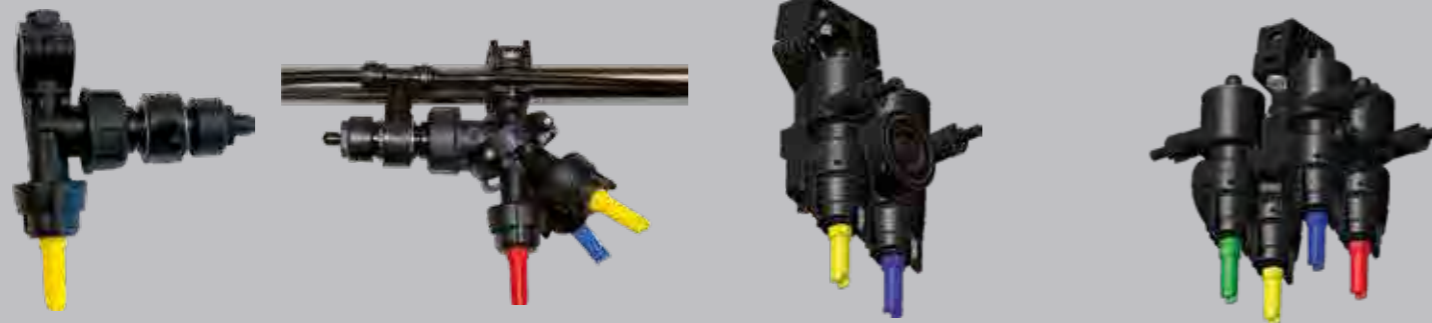

1 Single nozzle carrier

2 Triple nozzle carrier

3 Tandem nozzle carrier

4 Quattro nozzle carrier

Vario Select

(option)

- Constant drop size at alternating speed
- Automatic change between nozzles for nozzle carriers with multi-function switching
- Use of several nozzles on the tandem and quattro nozzle carrier
- Nozzle change without work interruption



MultiSelect

(option)

- Management of two nozzle sets per nozzle line
- Up to four nozzles per nozzle set possible
- Quick change from 25 to 50 cm
- Selection and control of the nozzle sets by Vario-Select on the ISOBUS terminal
- Use of single to quattro nozzle holders possible every 25 cm

Innovation

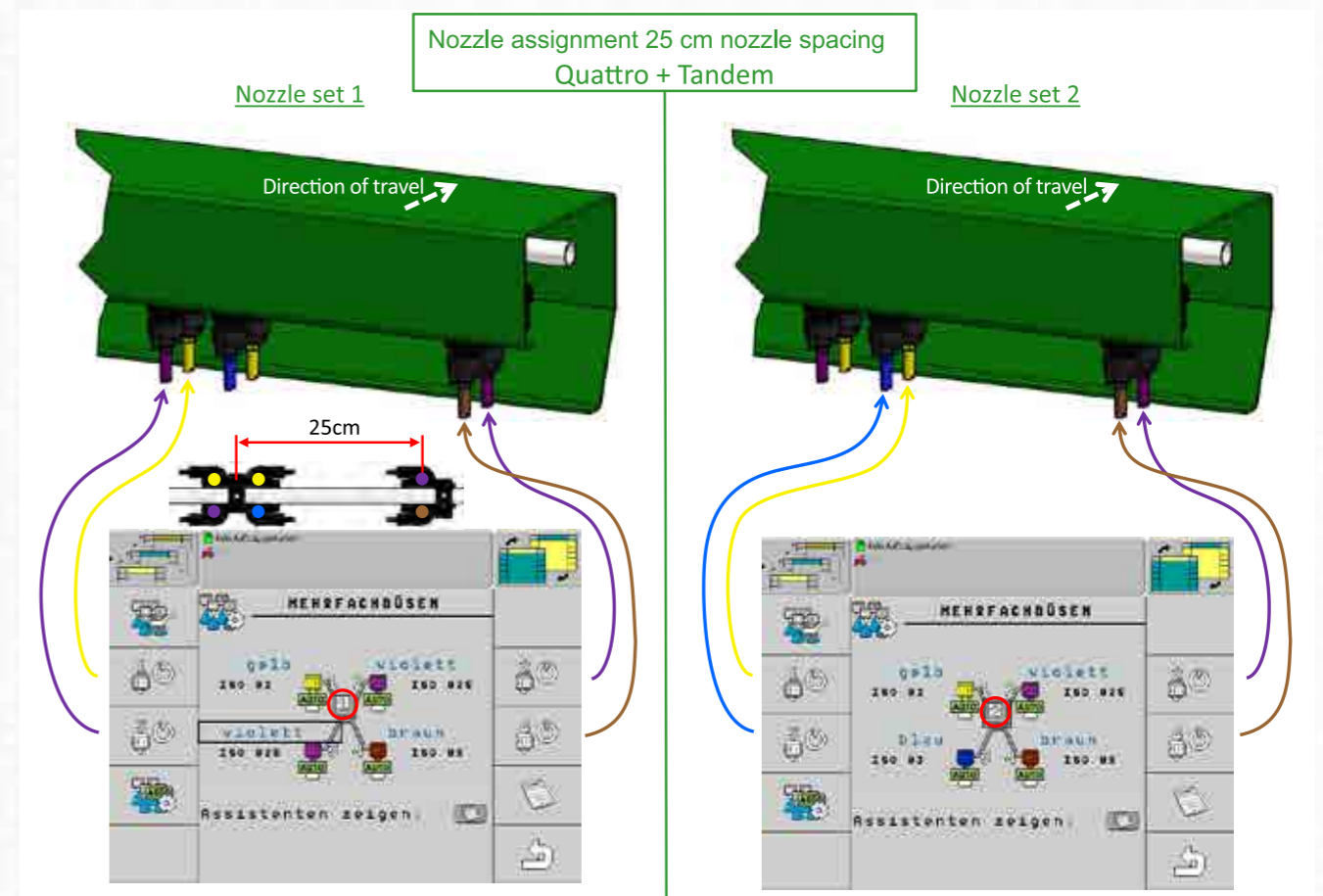

Partial EDS-pro (TB-EDS-pro)

(option)

- Up to 18 sections can be switched independently of each other via ISOBUS
- Incl. VarioSelect software
- Incl. C~C~A® Curve~Control~Application (recommendation: Quattro nozzle holder)
- More precise SECTION-Control ► thus higher savings potential in the PSM area

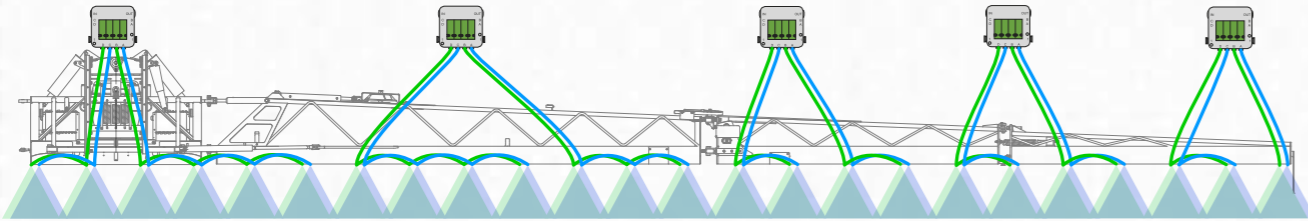

E-D-S — Individual Nozzle Control

(option)

- Savings potential by reducing the total overlap area
 - Less than 1% overlap possible due to GPS-controlled circuitry
 - 10 - 15 % savings in pesticides possible
- User friendly

E-D-S

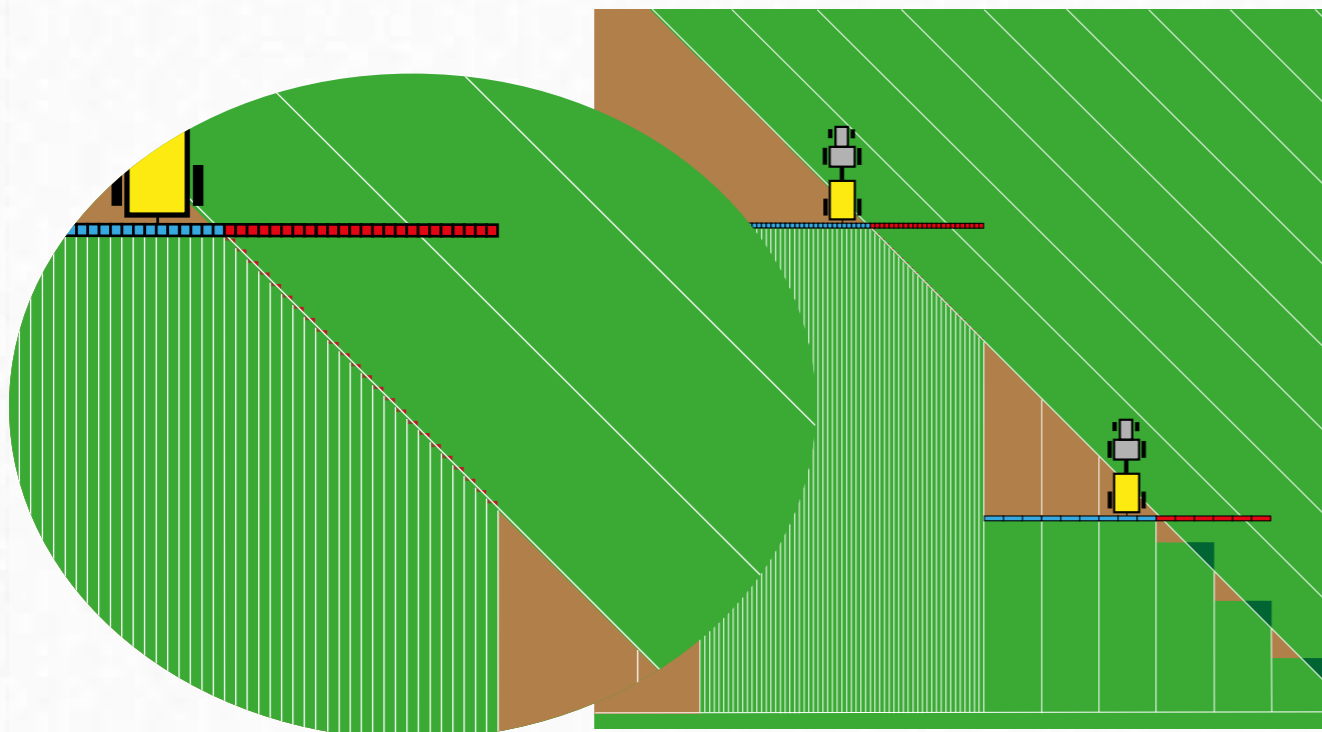

T-S-D — Partial Area Specific Nozzle Switching

(option for TB-EDS-pro or EDS)

- Different application rates for the individual boom sections

T-S-D



S-D-S

S-D-S — Sensor Nozzle Control

(option for TB-EDS-pro or EDS)

- Spray rate after sensor measurement
- 2, 4 or 6 sections with one sensor each
- Data exchange with the external computer unit

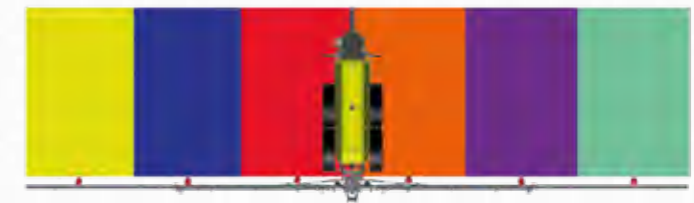

C ~ C ~ A® — Curves ~ Control ~ Application

(option for TB-EDS-pro or EDS)

- Calculates the different spray rate in curves
- Sensors determine the curve radius

C C A
Curves ~ Control ~ Application



Booms

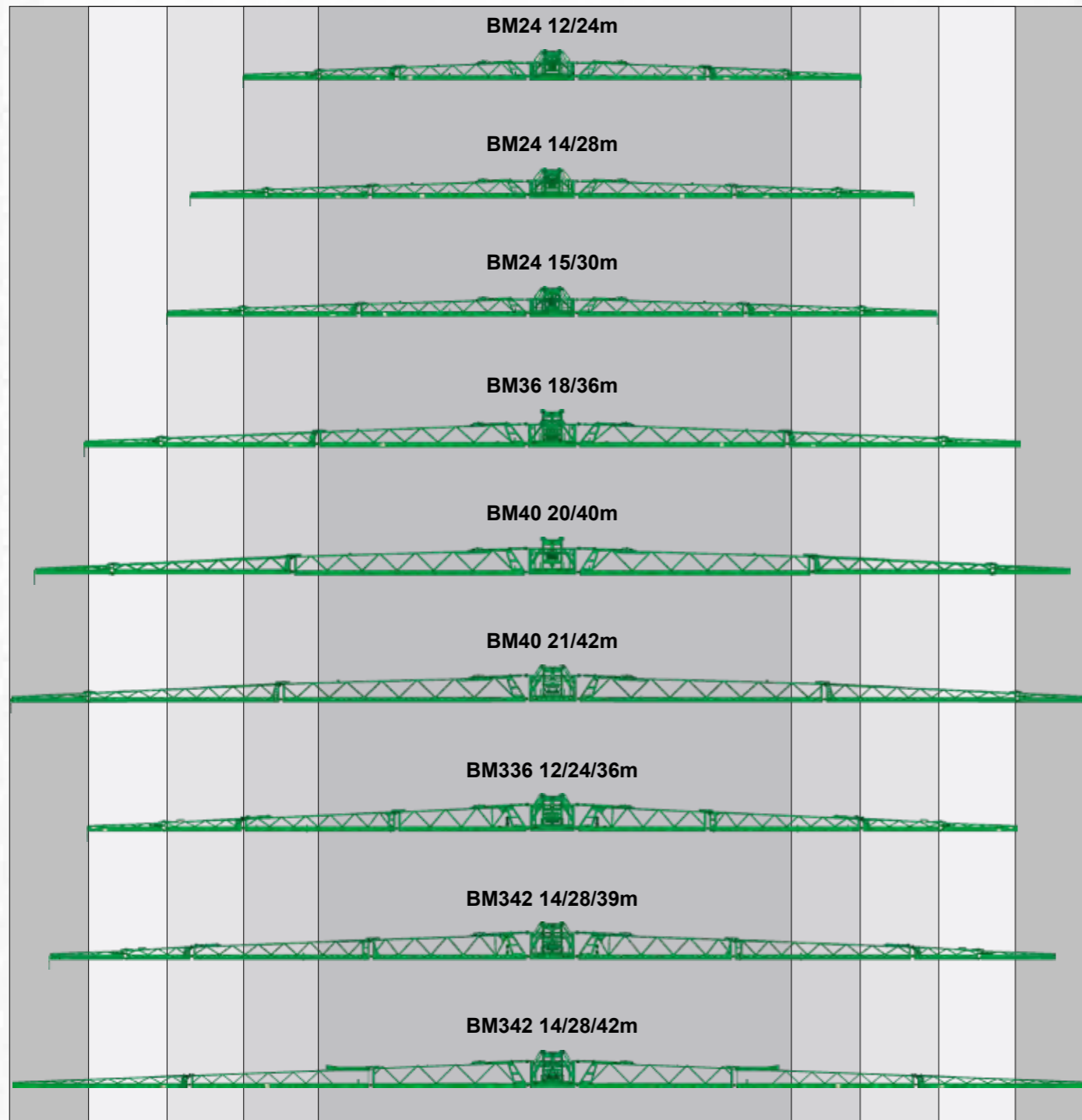

Booms can be shortend in the outer part

G-Booms

- Sturdy sprayer boom with hydraulic folding and special G-shape for protection of the nozzles
- Standard slope control for work on hilly terrain
- Electropneumatic slope compensation via double cylinder
- Outer aluminium booms for weight reduction with collision protection
- Spring-loaded, horizontally and vertically damped boom suspension
- Sturdy lift mast with stepless height adjustment without weight shifting
- Stable pendulum suspension for quiet boom guidance, even in hilly terrain



Flexible Working Width

(option)

- On different strokes through:
 - Flange plates
 - Folding hinges
 - Hydraulic folding hinges
 - Special folding at the pivot point
- Controllable via the ISOBUS terminal



DCD — Distance Control DAMMANN

(option)

- Combines the advantages of hydraulics (speed) and pneumatics (gentle repositioning) in one boom control system
- Monitoring of the optimum boom position by ultrasonic sensors
- Detection and anticipation of gravitational forces in curves
- Quick and easy operation
- Precise boom working height above the crop in the
- Terminal adjustable
- Calibration of the boom control takes place via the terminal
- Possible types of control depending on the equipment of the DCD's
 - Raising/lowering the boom
 - Tilting the boom
 - Angling (optional negativ angling) of the boom
 - Lifting/lowering + tilting the boom
 - Raising/lowering + angling (optional negativ angling) of the boom
- Switching off the height control
 - Manually by the operator
 - Automatically with the maximum permissible excavation height



Boom Angling and Negativ Angling

(option)

- Perfect extension for boom control
- Angle of advantage in cropped terrain
- Keeps constant distance through sensors to the inventory



Fluid Circuit

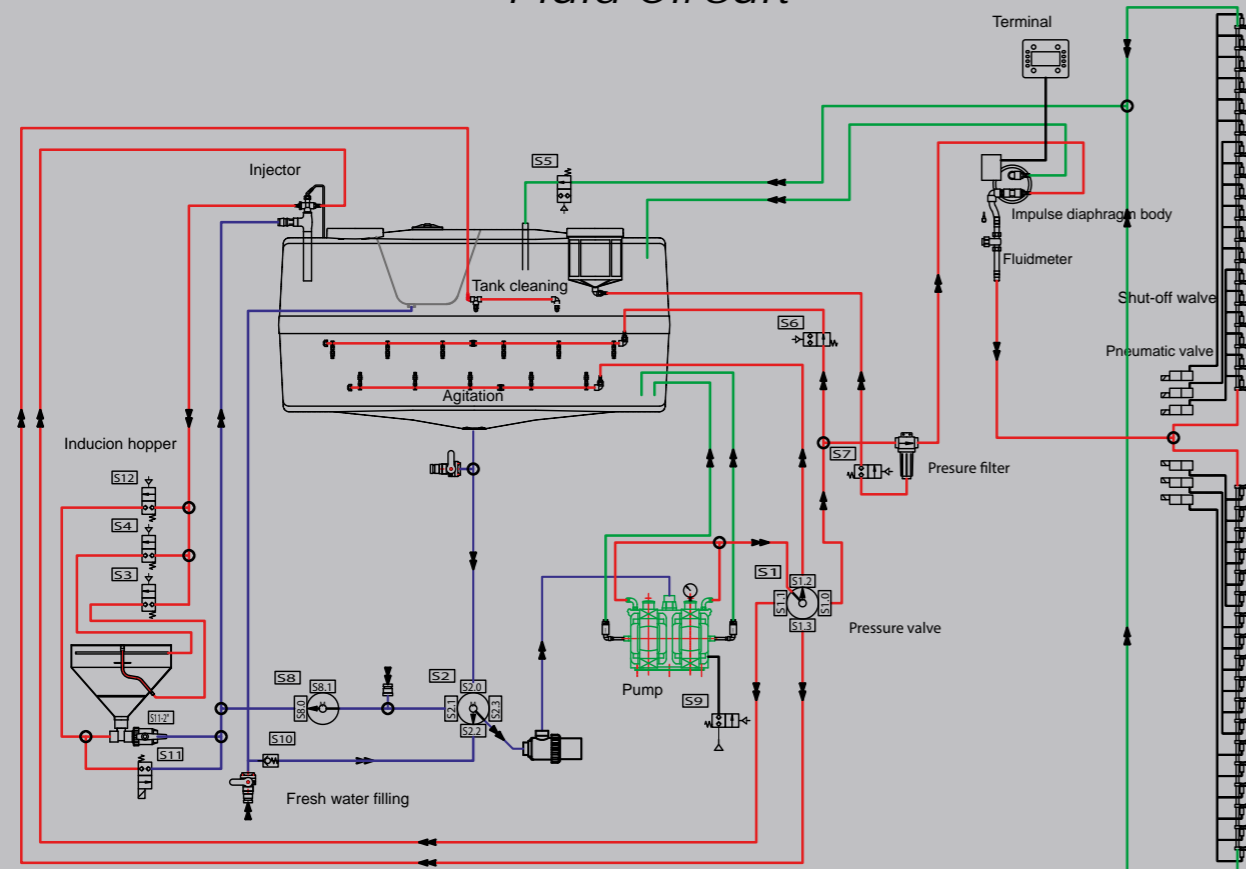

Pneumatic Constant-Pressure Diaphragm Body

- Always ensures constant spraying pressure due to pneumatic counterpressure in the lines, even with open or closed nozzles



Induction Hopper and Injector

- 60 l volume
- Fresh water supply during filling, ergonomic working height
- With ring flushing, which produces a rotating liquid flow. For dilution and lump-free irrigation of plant protection agents.
- Jet nozzle - for easy loosening of solid clumps
- Integrated, powerful canister flushing system for containers
- Pneumatic lifting and lowering of the induction bowl
- Ergonomic and user-friendly working height
- Injector enables the suction of solids from the induction centre into the tank
 - System suction capacity with pump and injector up to 800 l/min
 - Faster filling of the tank



EasyControl

Digitale fill level indicator

- Integrated in the ISOBUS system
- Switching functions of the ISOBUS system on the device
- Work lights, agitator, filter flushing, ...
 - CID and RRW are controlled via *EasyControl*

Innovation



Tank

- Proven case shape
- GFK coated
- Easy cleaning due to smooth inner walls
- Baffles for additional safety
- Integrated fresh water tank

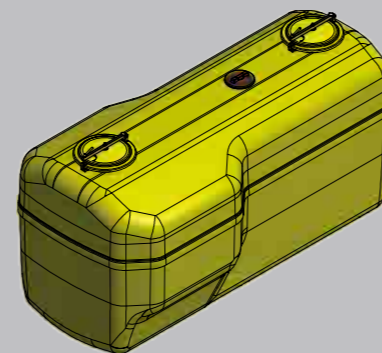

Pump

- Self-priming piston diaphragm pump
- Robust and durable design
- Pump capacity from 320 - 750 l/min depending on equipment and customer requirements



proControl III

(option)

- For recurring filling and cleaning processes
- Automated cleaning modes
- Easy to use
- The functions of proControl III can be controlled from the cabin via the ISOBUS terminals
- Remote control of the valves on the machine
- Leave additional functions, such as pump or lighting
- Operate via the terminal on the device
- ProControl III also cleans the induction hopper during cleaning processes





MFS — Multi-Fluid-System

Two tanks in one sprayer.

(option)

- One tank with two parts
- Two spray systems
- One terminal
- One or two nozzle lines
- One induction bowl for both systems



Multi - Fluid - System

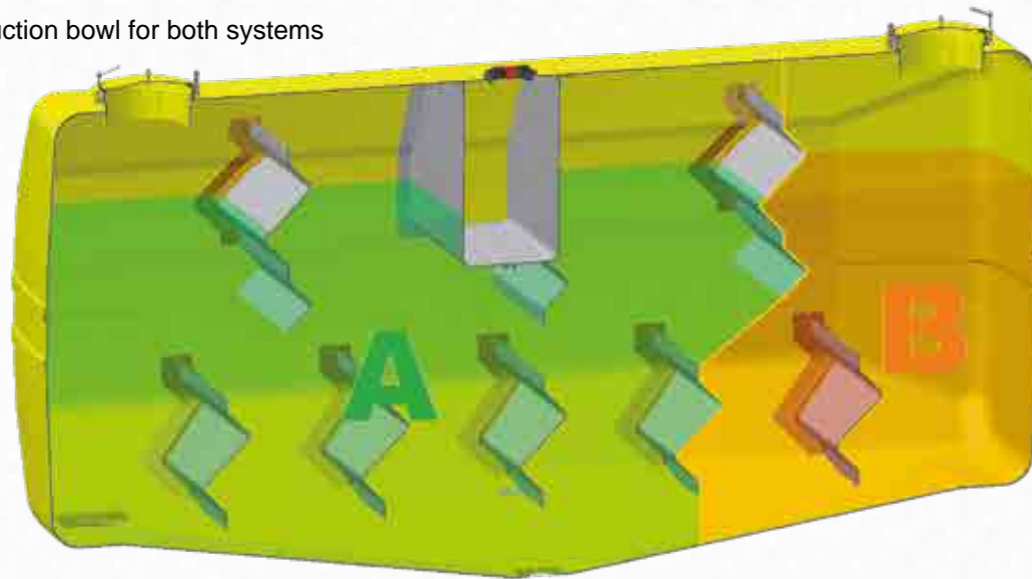

External Filling

(option)

- Filling via 2" or 3" external filling connection with Camlock coupling and shut-off valve
- Filling via hydrant filling connection with C- or B-coupling and non-return valve
- Pneumatic emptying of the external filling hose
- Bypass at the injector for direct external filling

Filling Pump

(option)

- Filling with 900 l/min
- Hydraulically driven

Inside Cleaning



RRW — Rotating Agitator and Cleaning Unit

(option)

- Central mounting in the lower part of the tank
- Special injector nozzles for stirring and cleaning the tank
- The swivel angle is controlled as a function of the filling level
- The driver can start the cleaning program via *EasyControl* in the cab
- Complete tank interior cleaning through 360° rotation of the nozzle shaft
- JKI tested

CID - Continuous Insidecleaning DAMMANN

(option)

- Level sensor-controlled automatic start of CID, interrupts cleaning if the level is too high
- Easy handling and thorough cleaning of the crop protection implement
- High cleaning efficiency with lower fresh water requirement
- High user protection, as the driver can start internal cleaning from the cab or via *EasyControl*
- Easy handling prevents point loads of PSM into surface waters due to improper handling cleaning (environmental protection)
- No premature dilution of the spray liquid due to operating errors
- Sufficient fresh water remains in the fresh water tank for the final interior and exterior cleaning
- JKI tested





D-A-S Dual-Air-System

The intelligent solution for the environmentally conscious economist

- Reduced drift, even with low stand heights and on bare soils
- Greater independence from weather influences - treatment time windows are increased
- Higher travel speeds, resulting in increased area performance
- More even active ingredient accumulation in the stock
- Stronger crop penetration, especially for special crops such as vegetables, salads or potatoes
- The powerful air jet turns the active ingredient into the target area even in high populations (e.g. maize)
- Better active ingredient accumulation in the stock leads to less evaporation losses at high temperatures
- Reduction of medium and water application rates
- Devices are entered in the JKI's list of „loss-reducing devices“



ohne D-A-S



mit D-A-S

Lighting and Exterior Cleaning

Best possible and safe working at dusk and at night.

HD-Night LUX

(option)

- Each spraying cone is illuminated by an LED
- Optical control of the function of all activated nozzles
- No overilluminated field
- With the special obstacle finder, the operator can identify obstacles and reacting to them in good time

LED Worklight

(option)

- Mounting of two or four LED worklights
- Positioning of the lighting according to customer requirements

Exterior Cleaning

(option)

DAMMANN offers three optional options for exterior cleaning:

- Washing brush with hose reel
- Vario spray pipe with hose reel - 15 bar
- High pressure cleaner with 120 bar, hydraulically driven

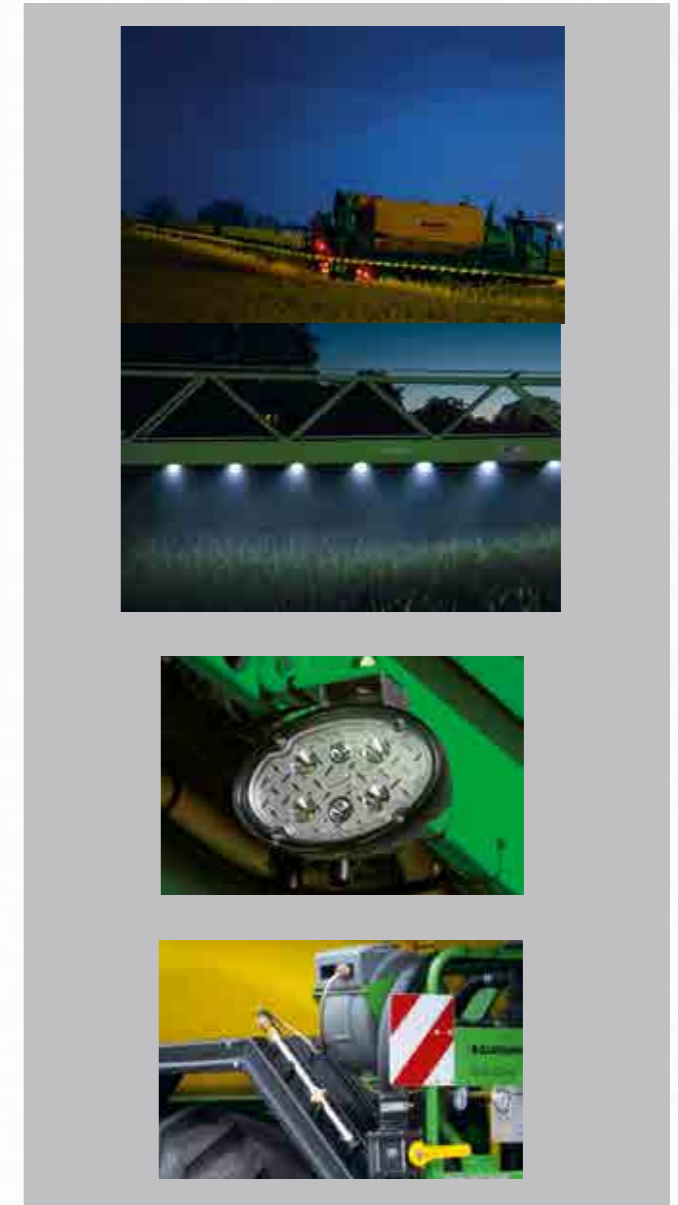

Wheels and Tyres

	DT 2800H S5		DT 3500H S5		DT2400H S5	
	fixed track width	track adjustment	fixed track width	track adjustment	fixed track width	track adjustment
380/90 R46	-	-	-	-	•	2,25 - 3,05 m
380/90 R50	•	1,80 - 2,25 m / 3,00 m / 3,30 m	○	1,80 - 2,25 m / 2,25 - 3,00 m	-	-
420/80 R46	-	-	-	-	○	2,30 - 3,10 m
480/80 R42	-	-	-	-	○	2,37 - 3,17 m
480/80 R46	○	1,95 - 2,25 m / 3,00 m / 3,30 m	○	1,95 - 2,25 m / 2,25 - 3,00 m	-	-
520/85 R38	-	-	-	-	○	2,41 - 3,21 m
520/85 R42	○	2,00 - 2,25 m / 3,00 m / 3,30 m	•	2,00 - 2,25 m / 2,25 - 3,00 m	-	-
580/70 R42	○	2,05 - 2,25 m	○	2,05 - 2,25 m	-	-
620/70 R42	○	2,10 - 2,25 m	○	2,10 - 2,25 m	-	-
650/65 R42	○	2,10 - 2,25 m	○	2,10 - 2,25 m	-	-

• standard, ○ option - not possible

Notice: Observe national restrictions on vehicle width

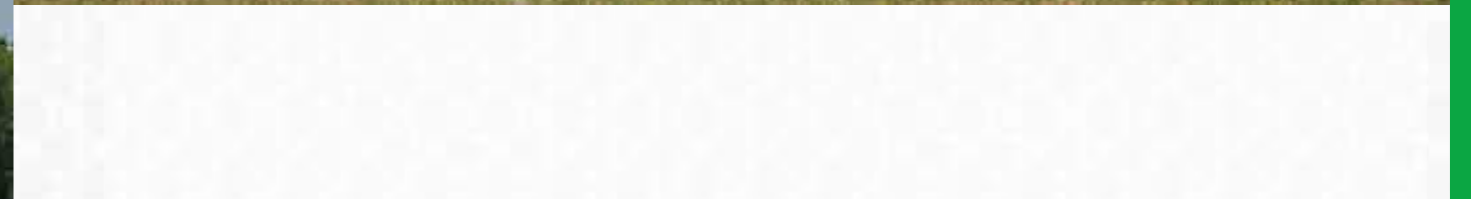

DAMMANN®



**Pflanzenschutztechnik
Fahrzeugtechnik
Airporttechnik**



HERBERT DAMMANN GmbH
Dorfstr. 17
21614 Buxtehude-Hedendorf
Tel.: +49 4163 8163-0
Fax.: +49 4163 8163 71
Web: www.dammann-technik.de
Mail: info@dammann-technik.de